

ENMET

680 Fairfield Court
Ann Arbor, MI 48108
734.761.1270 Fax 734.761.3220

www.enmet.com

ENMET

Creative Gas Detection Solutions



**EX-5185-PID
Toxic Gas
Sensor Transmitter
Operation and Maintenance Manual**

Table of Contents

1.0 INTRODUCTION	2
1.1 Unpack.....	2
1.2 Check Order.....	2
1.3 Serial Numbers.....	2
2.0 FEATURES OF THE EX-5185	3
3.0 INSTALLATION OF THE EX-5185	4
3.1 Mounting the EX-5185 Enclosure.....	4
3.2 Wiring the EX-5185 to a Control Unit.....	5
4.0 OPERATION OF THE EX-5185	7
4.1 Start up.....	7
4.1.1 Typical Start Up.....	7
4.2 Normal Display Mode.....	8
4.2.1 Alarm Conditions EX-5185.....	8
5.0 MAINTENANCE OF THE EX-5185	9
5.1 Maintenance Menu.....	9
5.2 Calibration of the EX-5185.....	10
5.2.1 Zero Adjust.....	12
5.2.2 Gas Span.....	12
5.2.3 Exit Maintenance Menu.....	12
5.3 Heater Voltage Settings.....	14
5.4 Sensor Replacement.....	14
6.0 REPLACEMENT PART NUMBERS	15
7.0 TERMS AND CONDITIONS	16
7.1 Ordering Information.....	16
7.2 Delivery.....	16
7.3 Payment Terms.....	16
7.4 Warranty Information and Guidelines.....	16
7.5 Return Policy.....	16
8.0 INSTRUCTIONS FOR RETURNING AN INSTRUMENT FOR SERVICE	17

List of Figures

Figure 1: EX-5185 Features.....	3
Figure 2: EX-5185 Mounting Dimensions.....	4
Figure 3: Terminal Positions EX-5185 Sensor/Transmitter.....	6
Figure 4: Calibration Adapter EX-5185 Sensor/Transmitter.....	10
Figure 5: EX-5185 Maintenance Menu Flow Chart.....	14
Figure 6: Sensor Replacement.....	14

List of Tables

Table 1: EX-5185 Maintenance Menu Sequence.....	9
Table 2: Examples of Standard Calibration Gas.....	11

Reference Information:

NOTE: [important information about use of instrument]

CAUTION: [affects equipment – if not followed may cause damage to instrument, sensor etc....]

WARNING: [affects personnel safety – if not followed may cause bodily injury or death.]



Attention / Warning



Earth Ground

1.0 Introduction

The **ENMET EX-5185** sensor/transmitters (S/T) is a 3-wire, 24 VDC 4-20mA S/T for the detection of toxic gas, utilizing a Photoionization detector (PID) sensor. The **EX-5185** is meant to be used in conjunction with an appropriate power supply and controller. The **ENMET EX-5185** sensor/transmitter has been designed and approved to be used in a Class I, Div. 1, Groups B, C, D, classified areas. The approval was issued by CSA International.

NOTE: *All specifications stated in this manual may change without notice.*

1.1 Unpack

Unpack the **EX-5185** and examine it for shipping damage. If such damage is observed, notify both **ENMET** customer service personnel and the commercial carrier involved immediately.

Regarding Damaged Shipments

NOTE: *It is your responsibility to follow these instructions. If they are not followed, the carrier will not honor any claims for damage.*

- This shipment was carefully inspected, verified and properly packaged at **ENMET** and delivered to the carrier in good condition.
- When it was picked up by the carrier at **ENMET**, it legally became your company's property.
- If your shipment arrives damaged:
 - Keep the items, packing material, and carton "As Is." Within 5 days of receipt, notify the carrier's local office and request immediate inspection of the carton and the contents.
 - After the inspection and after you have received written acknowledgment of the damage from the carrier, contact **ENMET** Customer Service for return authorization and further instructions. Please have your Purchase Order and Sales Order numbers available.
- **ENMET** either repairs or replaces damaged equipment and invoices the carrier to the extent of the liability coverage, usually \$100.00. Repair or replacement charges above that value are your company's responsibility.
- The shipping company may offer optional insurance coverage. **ENMET** only insures shipments with the shipping company when asked to do so in writing by our customer. If you need your shipments insured, please forward a written request to **ENMET** Customer Service.

Regarding Shortages

If there are any shortages or questions regarding this shipment, please notify **ENMET** Customer Service within 5 days of receipt at the following address:

ENMET
680 Fairfield Court
Ann Arbor, MI 48108
734-761-1270 Fax 734-761-3220
Toll Free: 800-521-2978

1.2 Check Order

Check the contents of the shipment against the purchase order. Verify that the **EX-5185** is received as ordered. [Each **EX-5185** is labelled with its target gas.] If there are accessories on the order, ascertain that they are present. Check the contents of calibration kits. Notify **ENMET** customer service personnel of any discrepancy immediately.

1.3 Serial Numbers

Each **EX-5185** is serialized. These numbers are on tags on the equipment and are on record in an **ENMET** database.

2.0 Features of the EX-5185

See **Figure 1** for location of features:

Feature	Description
Display	LCD: Indicates the level of gas detected by sensor
Gain Potentiometer (POT)	POT 1: Display contrast adjustment POT 2: Does Not apply to PID, not used <i>Do not adjust</i> POT 3: Does Not apply to PID, not used <i>Do not adjust</i> POT 4: Does Not apply to PID, not used <i>Do not adjust</i>
Visual Alarms	LED indicators: Power / Fault Indicator LED, Green / Red Alarm (3) Indicator Red LED, user adjustable
Magnetic Switches	MENU: Advances the instrument display through menus (Zero, Span, Exit) SELECT: Selects the Zero, Span, exit menu or sets proper calibration values for Zero or Span
Sensor	For sensing gas at PPM

Magnetic switches control the instrument maintenance functions. The switch locations are indicated by **MENU** and **SELECT**. A magnetic field pulse is applied by momentarily putting the end of the magnet in proximity to the switch and then removing it. Referred to as tap. Since the magnetic field penetrates the window, the enclosure cover is not removed to perform calibration.

Three alarm points are preprogrammed into the **EX-5185** sensor/transmitters. At each alarm point, an LED on the front panel is activated. These internal alarm settings are independent of the 4-20mA output alarm values that can be set at a controller.

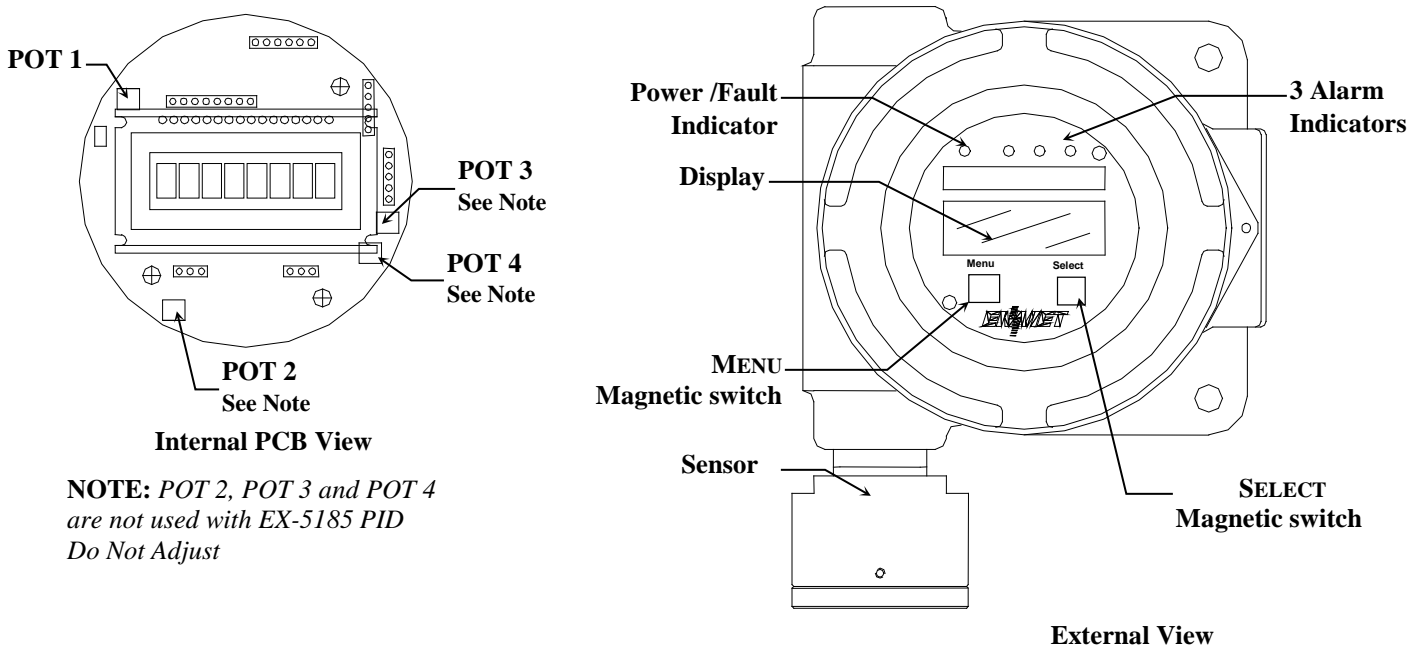


Figure 1: EX-5185 Features

3.0 Installation of the EX-5185

CAUTION: Area must be declassified during installation.

The **ENMET EX-5185** gas sensor/transmitter (S/T) is a 3-wire, 24 VDC, 4-20 mA S/T for the detection of toxic gas. The S/T is meant to be used in conjunction with an appropriate power supply and controller. The **ENMET EX-5185** sensor/transmitter has been designed and approved to be used in a Class I, Div. 1, Groups B, C, D, classified areas. The approval was issued by CSA International. Appropriate wiring, conduit and fittings are required for proper installation in a explosion proof rated environment.

CAUTION: Since the sensor/transmitter detects gas only at the sensor location, pay attention to the possible sources of gas, the density of the gas, locations where the gas may be confined and locations where the gas may damage or injure property or personnel, when choosing locations of sensor/transmitters.

Also, take into consideration environmental factors when deciding on S/T location. Avoid locations where the S/T may be damaged by liquid immersion, excessive heat or other know hazards. Also, take precautions to insure condensation inside of the conduit does not enter the S/T.

3.1 Mounting the EX-5185 Enclosure

Mount the enclosure, using the two mounting holes provided see **Figure 2**. Pay particular attention to the source and density of the gas being detected when choosing the location. Mount the S/T near the ceiling for lighter than air gases /vapors and near the floor for heavier then air gas/vapors. Contact **ENMET** if you have questions regarding your application.

CAUTION: Before connecting S/T to controller remove the power source to controller. Failure to do so may cause damage to sensitive components.

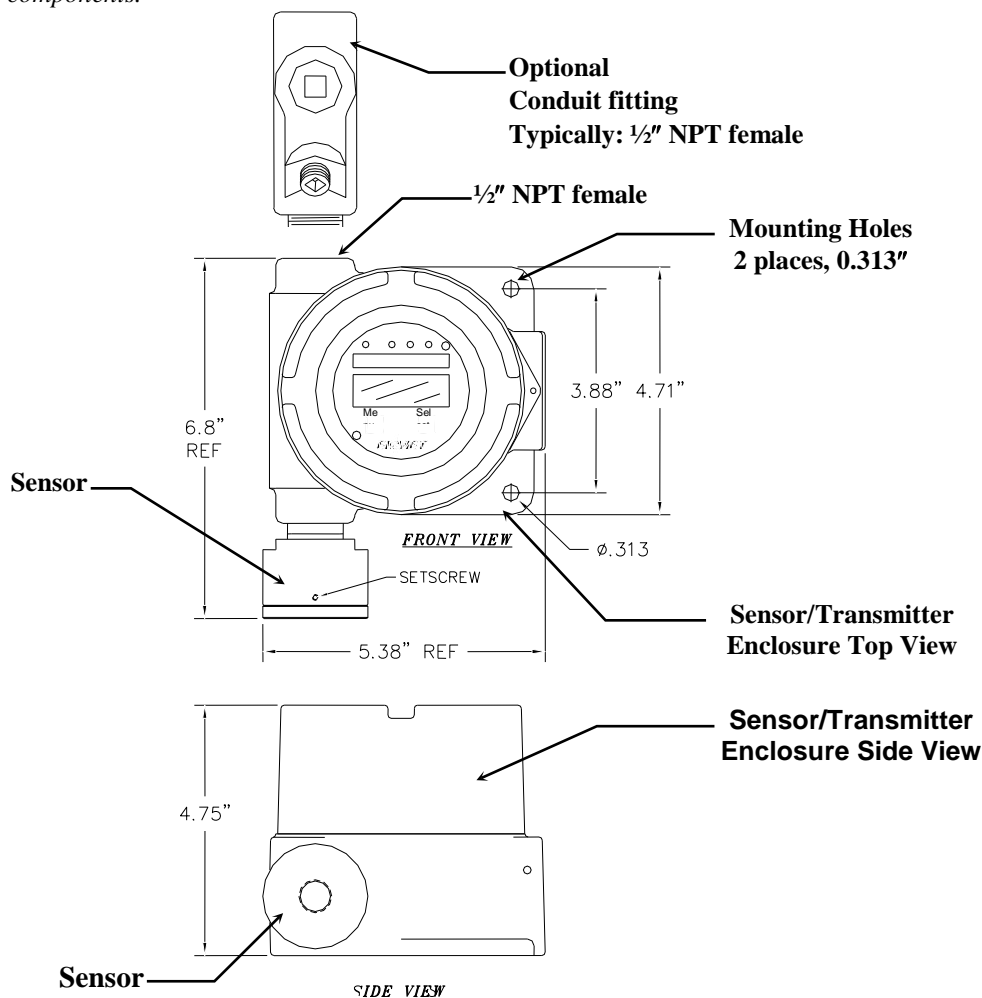


Figure 2: EX-5185 Mounting Dimensions

3.2 Wiring the EX-5185 to a Control Unit

CAUTION: Area must be declassified during installation.

Run conduit and 16 AWG (1.5MM²) wires to the enclosure from the power supply and controller. If the **EX-5185** is installed in a hazardous location as defined by the National Electrical Code, then *ALL* wiring must be in accordance with the National code and any local governing codes.

Open the enclosure, and remove the 2 screws that retain the display overlay to the circuit board.

Use caution when removing the over lay. Do not damage the magnetic switches.

Remove the two overlay standoffs and remove the circuit board, exposing the terminal strips on the bottom of the circuit board.

Do not disconnect the circuit board wiring.

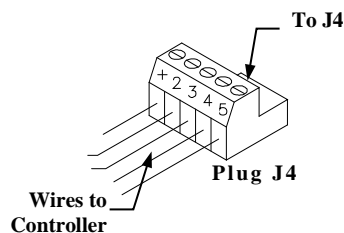
Connect the wires from the controller (power supply) to the supplied J4 plug then attach to J4 terminal.

Connect the wires from the sensor to the supplied J8 plug then attach to the J8 terminal.

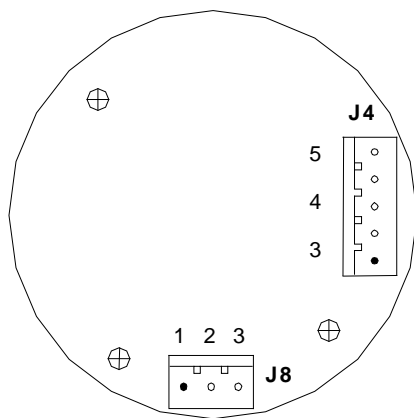
See **Figure 3** for locations

J4 PLUG – TERMINAL TO CONTROLLER WIRING

Position	Function
1 +	24 VDC power
2	GND
3	4 - 20 mA out
4*	RS-485 D+
5*	RS-485 D-



*Contact **ENMET** for Modbus address information



Circuit Board Bottom View

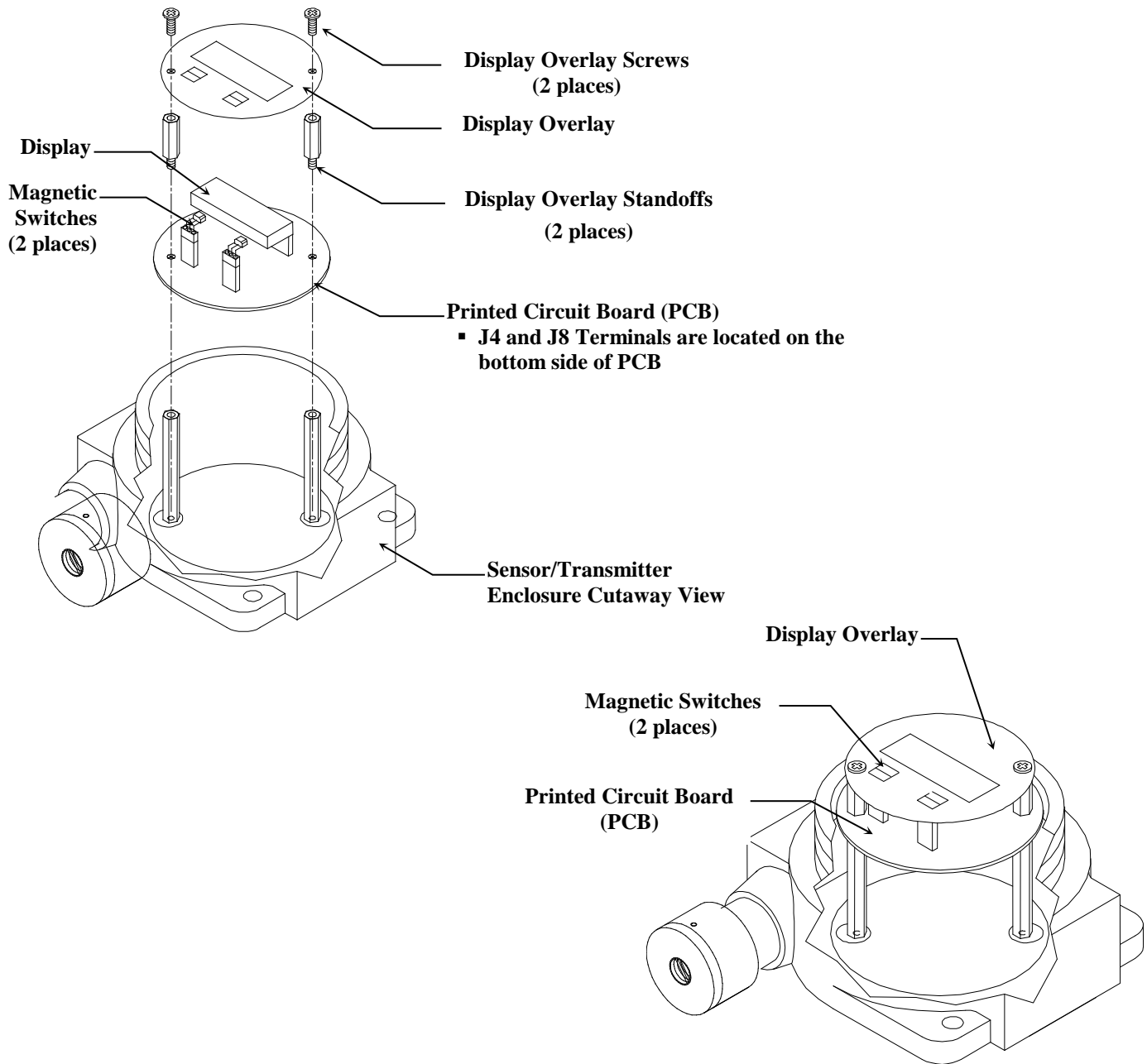


Figure 3: Terminal Positions EX-5185 Sensor/Transmitter

When wiring is complete, reassemble the **EX-5185**. Use caution when installing the overlay so as not to damage the magnetic switches. Put the cover back on the S/T *Do Not* apply power to the S/T without the cover in place.

4.0 Operation of the EX-5185

It is best to have the **EX-5185** transmitters powered up and operational for 24 hours before applying calibration or test gas to them. When the **EX-5185** transmitter is first powered up, it goes through a series of momentary screens, which identify the instrument model number, serial number and software revision. After all of the momentary screens have been displayed, the instrument arrives at the Main Gas Display showing the gas concentration and unit of measurement.

Depending on transmitter configuration and calibration condition, the furthest right character in the display may flash a letter indicating the instrument status. See the Section 4.1.2 below.

4.1 Start up

4.1.1 Typical Start Up

When power is supplied to the **EX-5185**, the S/T will display the following sequence of information:

NOTE: *Software revision may cause variations of display output.*

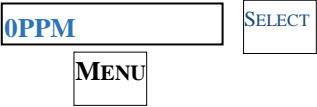
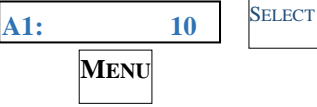
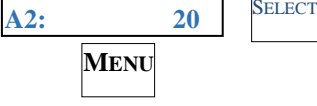
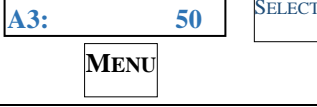
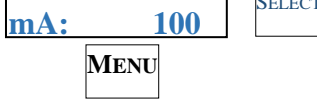
Example of Display	Function
EX-5185	The instrument: Model EX-5185 Note PID is not displayed
80-1256	The instrument: Serial Number
S/W X.X	The instrument: Software Revision
IF the right most character is a flashing W <div style="text-align: center;">0ppmW</div>	The instrument is in Warm-up mode <ul style="list-style-type: none"> ▪ This should last about 1 minute ▪ The Signal Output is held at 4mA during warm-up
0ppm For Toxic Gas	The instrument: Normal Display Mode Measurement of target Gas

4.2 Normal Display Mode

When the **EX-5185** is installed as described in section 3, and in clean air, the POWER green LED is on, the display is lit and the information on the display is measurement of the target gas detected by the **EX-5185**. The red alarm and fault LEDs are not lit. To advance through displays of operational information tap the magnet over the **MENU** button.

NOTE: *Software revision may cause variations of display output.*

See sequence of operational information below:

Display Measurement of the target gas Tap the magnet over the MENU button		No Function for the SELECT button in this mode
Display indicates Alarm 1 Set point Tap the magnet over the MENU button		
Display indicates Alarm 2 Set point Tap the magnet over the MENU button		
Display indicates Alarm 3 Set point Tap the magnet over the MENU button		
Display indicates mA Span range (Full Scale) Tap the magnet over the MENU button Display returns to gas measurement		

Operational Display Flow Chart

4.2.1 Alarm Conditions EX-5185

There are three alarm set points available. The alarm set points can be changed within limits; see the maintenance section of this manual for the procedure.

If the gas concentration increases above that of the alarm set point, the associated red LED is lit.

5.0 Maintenance of the EX-5185

CAUTION: Do not open the **EX-5185** S/T in a classified area.

CAUTION: *Do Not Attempt a Span Procedure Without Calibration Gas Applied to The Sensor*; if this is done, the S/T is forced into a calibration fault mode.


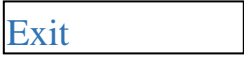
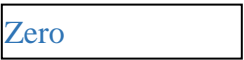
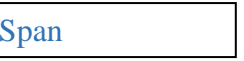
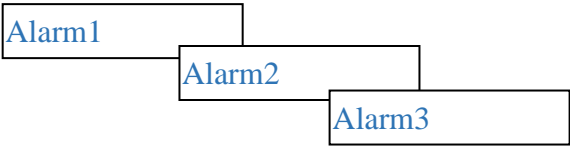

Magnetic switches control the **MENU** and **SELECT** functions. The **MENU** and **SELECT** switch locations are indicated on the display panel, see **Figure 3**. The **MENU** switch is used to display the various menu options and make incremental changes to numbers such as alarm points, calibrations gas, etc. The **SELECT** switch is used to select that option, set zero or span digit. Most maintenance functions are controlled by simple taps of the supplied magnet on the transmitter glass, below the **MENU** and **SELECT** boxes on the front panel.

5.1 Maintenance Menu

To enter the maintenance menu, hold the magnet over the **MENU** switch for 2 to 4 seconds

Table 1 indicates the maintenance menu sequence see **Figure 5** for a detailed maintenance menu flow chart.

Table 1: EX-5185 Maintenance Menu Sequence

Example of Display	Function
	Normal Display Mode Measurement of target gas
Hold the magnet over MENU switch for 2 – 5 seconds to enter the Maintenance Menu The Power/Fault LED will flash Green – Red to indicate the EX-5185 is in Maintenance Mode	
	To exit the maintenance Menu and return to the Normal Display Mode: If intended function, tap the magnet over SELECT switch
Tap the magnet over the MENU switch to advance to the Zero procedure	
	For adjusting Zero: If intended function, tap the magnet over SELECT switch
Tap the magnet over the MENU switch to advance to the Span procedure	
	For adjusting the Span: If intended function, tap the magnet over SELECT switch
Tap the magnet over the MENU switch to advance to each Alarm set point procedures	
	For adjusting the Alarm 1, 2 and 3 set points: If Intended function, tap the magnet over SELECT switch
Tap the magnet over the MENU switch to advance the mA Span set point procedure	
	For adjusting the mA Span set point: If intended function, tap the magnet over SELECT switch

Taping the **MENU** switch without taping the **SELECT** switch will allow you to cycle through the menu options. You must Tap the **SELECT** switch to change the desired operation.

NOTE: *If the S/T fails to respond, the magnet may have become weak and may need to be replaced.*

5.2 Calibration of the EX-5185

Calibration is the process of setting the instrument up to read accurately when exposed to a target gas. The Zero function sets the clean air reference point and the Span function sets the sensitivity of the instrument.

Initial Calibration: Wait 24 hours after initially supplying power to the **EX-5185** sensor/transmitter (S/T) before initial calibration. The S/T has been precalibrated at the factory, and initial field calibration should result in only fine tuning to circuit, as well to check that installation is successful. It is not necessary to open the enclosure to make adjustment. The calibration functions are operated with magnets from outside the enclosure through the MENU and SELECT switches. Do Not open the S/T unless the area is de-classified.

Calibration Zero and Span functions are two separate procedures. They operate independently of each other. It is recommended that the Zero procedure be done prior to the Span procedure. *ENMET* recommends at least quarterly calibration of the **EX-5185** transmitters.

Calibration equipment is available from *ENMET* to calibrate the **EX-5185** sensor/transmitters. A calibration adapter will have a fitting for the gas cylinder on one side, and a cover to go over the sensor housing on the other.

Generally, a cylinder of 20.9% Oxygen is used to provide a fresh air reference or Zero point for the calibration. Another cylinder is used to provide the Span reference point for calibration, typically Isobutylene. Depending on the instrument calibration, the Span gas may be the same gas that the instrument is calibrated to display, or it may be another gas, which *ENMET* has found to have a similar response. See **Table 2** for standard calibration gases.

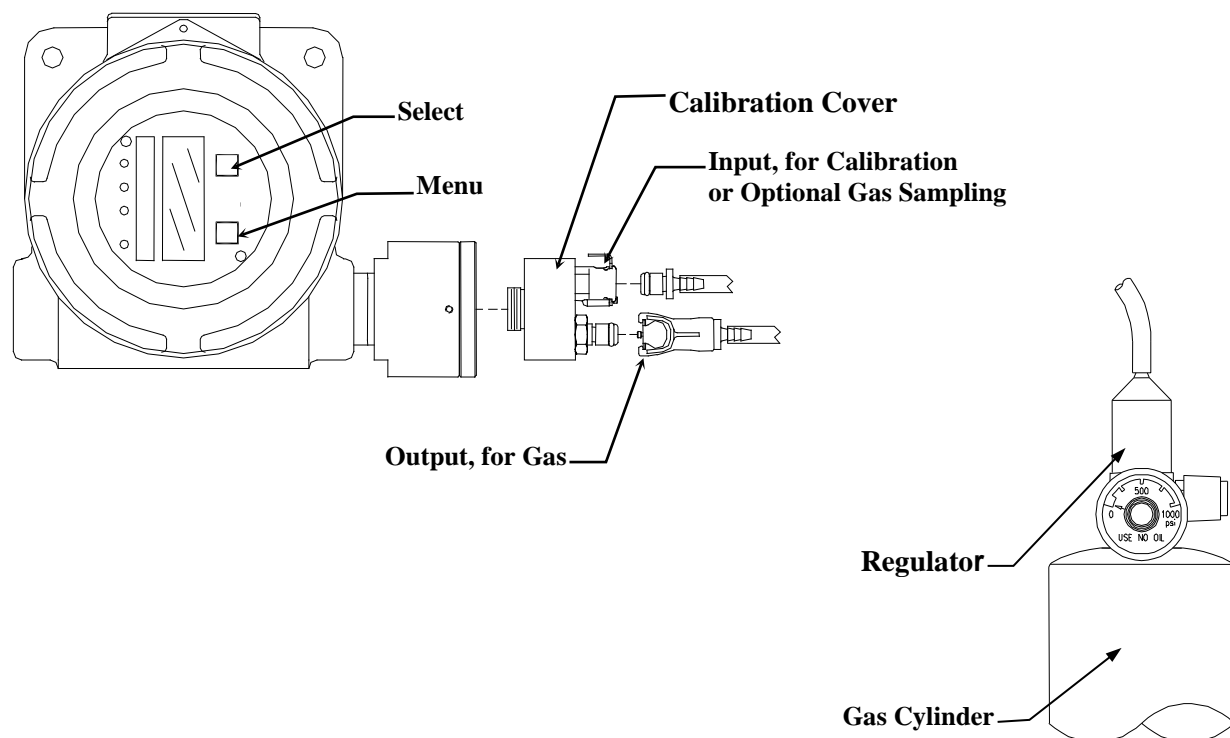


Figure 4: Calibration Adapter EX-5185 Sensor/Transmitter

Table 2: Examples of Standard Calibration Gas

Gas	Range	Alarm 1*	Alarm 2*	Alarm 3*	Sensor Part Number	Span Gas Isobutylene	Gas Cylinder Part Number
Benzene	0 - 20 ppm	0.5 PPM	1.0 PPM	5.0 PPM	03028-010	10 PPM	03290-010
1, 3-Butadine	0 - 20 ppm	0.5 PPM	1.0 PPM	5.0 PPM	03028-010	10 PPM	03290-010
Carbon disulfide	0 - 20 ppm	1.0 PPM	5.0 PPM	10 PPM	03028-010	10 PPM	03290-010
Chlorobenzene	0 - 200 ppm	50 PPM	75 PPM	100 PPM	03028-011	100 PPM	03290-100
Cyclohexanone	0 - 200 ppm	25 PPM	50 PPM	75 PPM	03028-011	100 PPM	03290-100
Diethylamine	0 - 20 ppm	5.0 PPM	10 PPM	15 PPM	03028-010	10 PPM	03290-010
Dimethyl acetamide	0 - 20 ppm	5.0 PPM	10 PPM	15 PPM	03028-010	10 PPM	03290-010
Hydrazine	0 - 20 ppm	0.5 PPM	1.0 PPM	5.0 PPM	03028-010	10 PPM	03290-010
Isobutyl acetate	0 - 2000 ppm	100 PPM	250 PPM	500 PPM	03028-012	750 PPM	03290-750
Isopropyl acetate	0 - 2000 ppm	100 PPM	250 PPM	500 PPM	03028-012	750 PPM	03290-750
Isopropylamine	0 - 20 ppm	0.5 PPM	1.0 PPM	5.0 PPM	03028-010	10 PPM	03290-010
Methyl bromide	0 - 20 ppm	5.0 PPM	10 PPM	15 PPM	03028-010	10 PPM	03290-010
Methyl ethyl Ketone	0 - 2000 ppm	100 PPM	250 PPM	500 PPM	03028-012	750 PPM	03290-750
Methyl mercaptan	0 - 20 ppm	0.2 PPM	0.5 PPM	1.0 PPM	03028-010	10 PPM	03290-010
Methylamine	0 - 20 ppm	5.0 PPM	10 PPM	15 PPM	03028-010	10 PPM	03290-010
Naphthalene	0 - 20 ppm	5.0 PPM	10 PPM	15 PPM	03028-010	10 PPM	03290-010
Octane	0 - 2000 ppm	100 PPM	250 PPM	500 PPM	03028-012	750 PPM	03290-750
Phenol	0 - 20 ppm	5 PPM	10 PPM	15 PPM	03028-010	10 PPM	03290-010
Tetrachloroethylene	0 - 200 ppm	75 PPM	100 PPM	150 PPM	03028-011	100 PPM	03290-100
Toluene	0 - 2000 ppm	100 PPM	250 PPM	500 PPM	03028-012	750 PPM	03290-750
Trichloroethylene	0 - 20 ppm	5 PPM	10 PPM	15 PPM	03028-010	10 PPM	03290-010
Trimethylbenzene	0 - 20 ppm	5 PPM	10 PPM	15 PPM	03028-010	10 PPM	03290-010
Vinyl; acetate	0 - 20 ppm	0.5 PPM	1.0 PPM	5.0 PPM	03028-010	10 PPM	03290-010
Vinyl chloride	0 - 20 ppm	0.2 PPM	0.5 PPM	1.0 PPM	03028-010	10 PPM	03290-010

NOTE: The detectable range and the availability of span/calibration gas dictates that for some gasses the span/calibration gas will not trigger the high alarm point.

NOTE: EX-5185 alarm points are independent of a controller. When a controller is supplied by ENMET the alarm points for the EX-5185 and the controller have been set accordingly. See the manual of the controller the EX-5185 sensor transmitter has been connected to for proper adjustment of the alarm points of the controller with the EX-5185 sensor transmitter.

5.2.1 Zero Adjust

A ZERO function should be performed only when the **EX-5185** sensor/transmitter is exposed to fresh air. If the air at the sensor is in question, use a cylinder of 20.9% oxygen to provide a clean air reference. Attach the cylinder to the calibration adapter, fill the humidifier bowl halfway with water and allow gas to flow over the sensor for 3 – 4 minutes.

Enter the maintenance menu by placing the magnet over **MENU** switch for 2 to 4 seconds. See **Figure 5, EX-5185** Maintenance Menu flow chart.

The second menu available is the Zero.

Tap the **SELECT** switch to perform a Zero.

- *If the Zero is successful*, Cal OK appears on the display and in 1 – 2 seconds, display will change to Span. If you wish to Span the sensor Tap the **SELECT** switch you are now ready to apply gas. **Proceed to gas span step 2**
If you wish to Exit the maintenance menu, Tap **MENU** switch until Exit is displayed, then tap **SELECT** switch to return to the instrument Normal Gas Display
- *If the Zero is Not successful*, sensor is outside of safe parameters to be zeroed, the display will read Bad Zero. Repeat Section 5.2.1 Zero Adjust making sure to use a cylinder of 20.9% Oxygen.

5.2.2 Gas Span

It is recommended that the Zero Function be performed first.

Enter the maintenance menu. See **Figure 5, EX-5185** Maintenance Menu flow chart.

1. Tap the **MENU** switch once to show Span on the display.
2. Tap the **SELECT** switch to perform a Span procedure. The display will alternate between the calibration gas concentration and a signal level.

NOTE: You can change the Calibration Gas Level. **HOLD** the magnet over the **SELECT** switch for 2 – 4 seconds.

The **MENU** switch changes digit indicated by underscore cursor

The **SELECT** switch locks underscored digit and moves to next digit

3. Attach the associated calibration gas cylinder to the regulator and calibration cover. See to **Figure 3**.
4. Open the valve to apply the calibration gas to the sensor.
5. Watch for the signal level to stabilize. Typical response time is 2 to 4 minutes.
6. Once the signal level has stabilized, the **EX-5185** will automatically lock in the calibration data and:
 - If the Span is successful, Cal OK appears on the display momentarily, then advances to Alarm 1. Remove calibration gas. To exit maintenance menu, tap the **MENU** switch until Exit appears, then tap the **SELECT** switch.
 - If the sensor is outside of acceptable parameters, Bad Span is displayed momentarily, then returns to Span. Remove calibration gas. Tap the **MENU** switch until Exit appears, then tap the **SELECT** switch. Check span gas and repeat calibration in 30 – 60 minutes.
 - If the sensor did not respond to gas, Same mV is displayed momentarily, then returns to Span.
 - ➔ Remove calibration gas, tap the **MENU** switch until Exit appears, then tap the **SELECT** switch and try calibration again in 30-60 minutes.
7. Calibration is complete.

5.2.3 Exit Maintenance Menu

Exit maintenance, by tapping on the **MENU** switch until Exit appears on the display. Tap the **SELECT** switch to return to the instrument Normal Gas Display.

Normal Display Mode

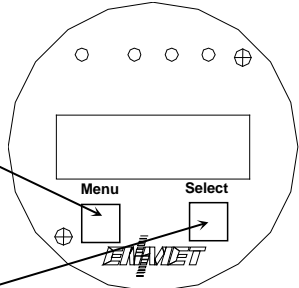
<div style="border: 1px solid black; padding: 2px; display: inline-block; width: 80%;">5ppm</div> <div style="border: 1px solid black; padding: 2px; display: inline-block; width: 80%;">MENU</div>	<p>HOLD the magnet over the MENU switch for 2 – 4 seconds to enter the Maintenance Menus</p>	
<div style="border: 1px solid black; padding: 2px; display: inline-block; width: 80%;">Exit</div> <div style="border: 1px solid black; padding: 2px; display: inline-block; width: 80%;">MENU</div>	<p>Tap the SELECT switch to return to the Normal Display Mode. <i>See Section 5.2.3</i></p> <p>Tap the magnet over the MENU switch to cycle through Maintenance Menus</p>	
<div style="border: 1px solid black; padding: 2px; display: inline-block; width: 80%;">Zero</div> <div style="border: 1px solid black; padding: 2px; display: inline-block; width: 80%;">MENU</div>	<div style="border: 1px solid black; padding: 2px; display: inline-block; width: 80%;">PV: 0</div> <div style="border: 1px solid black; padding: 2px; display: inline-block; width: 80%;">SELECT</div>	<p>Tap the SELECT switch to initiate Zero adjustment</p> <p>If the Zero signal is within Preset Specs the EX-5185-PID will display Cal OK, <i>See Section 5.2.1</i></p> <p>If the Zero signal is not within Preset Specs the EX-5185-PID will display Bad ZERO</p> <p>NOTE: Some software revisions require the SELECT switch be tapped to accept the signal.</p>
<div style="border: 1px solid black; padding: 2px; display: inline-block; width: 80%;">Span</div> <div style="border: 1px solid black; padding: 2px; display: inline-block; width: 80%;">MENU</div>	<div style="border: 1px solid black; padding: 2px; display: inline-block; width: 80%;">PV: 0</div> <div style="border: 1px solid black; padding: 2px; display: inline-block; width: 80%;">20</div> <div style="border: 1px solid black; padding: 2px; display: inline-block; width: 80%;">SELECT</div>	<p>NOTE: You can change the Calibration Gas Level.</p> <p>HOLD the magnet over the SELECT switch</p> <p>The MENU switch changes digit indicated by underscore cursor The SELECT switch locks underscored digit and moves to next digit <i>See Section 5.2.2</i></p> <p>Apply Calibration Gas until signal value becomes stable (about 1 to 4 minutes) <i>See Figure 4</i></p> <p>If cal is good display will indicate OK or Same</p> <p>If cal is not within preset “range” display will indicate Bad Sens</p>
<div style="border: 1px solid black; padding: 2px; display: inline-block; width: 80%;">Alarm1</div> <div style="border: 1px solid black; padding: 2px; display: inline-block; width: 80%;">MENU</div>	<div style="border: 1px solid black; padding: 2px; display: inline-block; width: 80%;">SELECT</div> <div style="border: 1px solid black; padding: 2px; display: inline-block; width: 80%;">A 10</div> <div style="border: 1px solid black; padding: 2px; display: inline-block; width: 80%;">SetTDsec</div> <div style="border: 1px solid black; padding: 2px; display: inline-block; width: 80%;">0</div>	<p>To change Alarm set points: Tap Menu switch until Alarm to be changed is displayed Tap Select switch to display the set point The MENU switch: changes digit indicated by underscore cursor The SELECT switch: locks in the underscored digit and moves to next digit</p> <p>If change is not within range display returns to first digit If change is within range display moves to Set Time Delay Use MENU and SELECT switches as above to change time delay. Between 0 and 5 seconds is allowed If change is within range display moves to next menu</p> <p>Λ - Indicates increasing alarm V - Indicates decreasing alarm</p>
<div style="border: 1px solid black; padding: 2px; display: inline-block; width: 80%;">Alarm2</div> <div style="border: 1px solid black; padding: 2px; display: inline-block; width: 80%;">MENU</div>	<div style="border: 1px solid black; padding: 2px; display: inline-block; width: 80%;">SELECT</div> <div style="border: 1px solid black; padding: 2px; display: inline-block; width: 80%;">A 20</div> <div style="border: 1px solid black; padding: 2px; display: inline-block; width: 80%;">SetTDsec</div> <div style="border: 1px solid black; padding: 2px; display: inline-block; width: 80%;">0</div>	
<div style="border: 1px solid black; padding: 2px; display: inline-block; width: 80%;">Alarm3</div> <div style="border: 1px solid black; padding: 2px; display: inline-block; width: 80%;">MENU</div>	<div style="border: 1px solid black; padding: 2px; display: inline-block; width: 80%;">SELECT</div> <div style="border: 1px solid black; padding: 2px; display: inline-block; width: 80%;">A 50</div> <div style="border: 1px solid black; padding: 2px; display: inline-block; width: 80%;">SetTDsec</div> <div style="border: 1px solid black; padding: 2px; display: inline-block; width: 80%;">0</div>	

Figure 5: Continued on next page

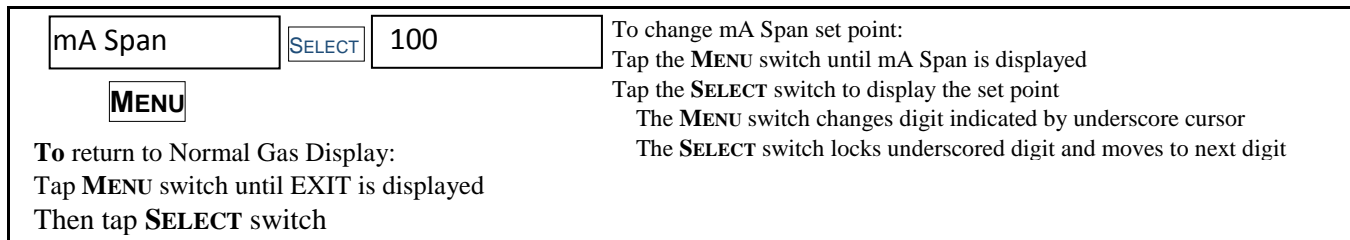


Figure 5: EX-5185 Maintenance Menu Flow Chart

5.3 Heater Voltage Settings

Heater Voltages are necessary for PID sensors. They are preset at the factory and should not require field adjustment. Do not adjust these voltages unless specifically instructed to do so by **ENMET** Technical Support Staff.

CAUTION: Improper adjustment of heater voltages can damage sensors voiding any warranties and also alter the operating characteristics of the sensor in such a way that the **EX-5185** may not respond to its target gas.

5.4 Sensor Replacement

CAUTION: Area must be declassified during sensor replacement.

Sensors should be replaced when they can no longer be calibrated. Replacement sensor part numbers are listed in Section 6.0 of this manual. If you do not know the proper part number for your sensor, be sure to have the **EX-5185** serial number available when contacting your Distributor or **ENMET** Technical Support.

To replace a sensor, it is not necessary to open the transmitter housing.
Remove the set screw from sensor housing base.
Unscrew the sensor housing cover and remove spacer. *Note the orientation of spacer.*
Unplug the sensor from PC Board.

Plug new sensor into PC Board and replace spacer. *Replace spacer with grooved edge toward sensor housing cover.*
Reassemble the sensor housing.
After the new sensor has been installed, it is suggested to allow the sensor to stabilize for 24 hours.

A Factory calibration must be performed.

After entering the Maintenance menu, advance to the Zero menu. Then while viewing the Zero menu, hold the magnet over the **MENU** switch for 2-4 seconds.

After 2-4 seconds, an F will appear on the far-right hand side of the display. The F indicates that the instrument is in Factory mode.

Perform the calibration Zero and Span procedures as outlined in Section 5.2. Be sure that the F is present when selecting the Zero and Span functions. The Factory calibration sets a calibration window for future standard instrument calibrations.

Only perform a factory calibration when installing a new sensor!!

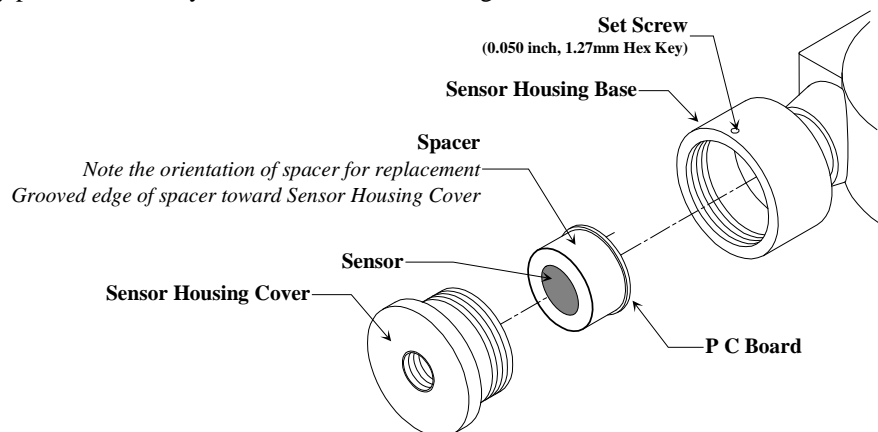


Figure 6: Sensor Replacement

6.0 Replacement Part Numbers

ENMET replacement part numbers:

Description	Part Number
EX-5185-PID p/n 10014-026, 0 – 20 ppm Sensor	03028-010
EX-5185-PID p/n10014-027, 0 – 200 ppm Sensor	03028-011
EX-5185-PID p/n10014-027, 0 – 2000 ppm Sensor	03028-012
Consult <i>ENMET</i> Distributor or <i>ENMET</i> for additional sensors	
Gas Regulator Assembly	02506-004
Overlay	06000-058
Magnet	50030-001
Calibration/Sampling Adapter	03700-034
Calibration Gas, 10 ppm Isobutylene	03290-010
Calibration Gas, 100 ppm Isobutylene	03290-100
Calibration Gas, 750 ppm Isobutylene	03290-750

7.0 Terms and Conditions

7.1 Ordering Information

Address orders to:

ENMET
Attention: Customer Service Department
680 Fairfield Court
Ann Arbor, MI 48108

Email Orders: orderentry@enmet.com

Phone: 734-761-1270

Fax: 734-761-3220

You may also contact our customer service department by email info@enmet.com. MINIMUM ORDER IS \$50.00.

7.2 Delivery

Unless Seller otherwise specifies, delivery will be made: FOB Ann Arbor, MI and/or FOB Bowling Green, KY. Title and risk of loss shall pass to Buyer at that point. Shipping and handling charges will be Prepaid and Added to Buyer's invoice. Buyer may request shipping be charged to their own account with a preferred carrier. Seller shall have the right to choose means of transportation and to route shipment when specific instructions are not included with Buyer's order. Seller agrees to deliver the goods and services, within the time, in accordance with specifications, at the prices specified on the face hereof. Buyer's orders to this quotation are not subject to cancellation or deferment of delivery without indemnification of loss to the Seller resulting therefrom. Seller shall not be liable to Buyer for any loss or damage sustained on account of this delay or nonperformance due to causes beyond Seller's control and without his fault or negligence. Where performance of the terms here is contingent upon timely delivery of goods or services by the Buyer and such delivery is in default, Seller shall be indemnified for any damage or loss resulting therefrom, and/or by extension of Seller's delivery commitment, as applicable.

7.3 Payment Terms

Payment Terms are Net 30 Days from the date of shipment from Seller unless otherwise noted. All shipping and handling costs will be charged to Buyer on a Prepaid and Add basis. Buyer has the option of paying for shipping by charging its own account with a carrier

7.4 Warranty Information and Guidelines

The Seller warrants new instruments to be free from defects in workmanship and material under normal use for a period of one year from date of shipment. The warrant covers both parts and labor excluding calibration and expendable parts such as filters, detector tubes, batteries, etc. If the inspection by the Seller confirms that the product is defective, it will be repaired or replaced at no charge, within the stated limitations, and returned prepaid to any location in the United States. The Seller shall not be liable for any loss or damage caused by the improper use or installation of the product. The Buyer indemnifies and saves harmless the Seller with respect to any loss or damages that may arise through the use by the Buyer or others of this equipment. This warranty is expressly given in lieu of all other warranties, either expressed, implied or statutory, including that of merchantability, and all other obligations, or liabilities of ENMET, LLC for damages arising out of or in connection with the use or repair or performance of the product. In no event shall ENMET, LLC, be liable for any indirect, incidental, special or consequential damages or for any delay in the performance by ENMET, LLC, which may arise in connection with this equipment. ENMET neither assumes nor authorizes any representatives or other persons to assume for it any obligation or liability other than that which is set forth herein. Buyer agrees to indemnify and save harmless Seller for any damage or loss from lawsuits against Seller by reason of manufacture of sale of materials, parts, or use of processes resulting from Buyer's design specifications. Any patent, design, pattern, tool, die, jig, fixture, drawing, test equipment, or process furnished by Seller; whether possessed by the Seller before the date of this quotation, or devised or acquired by Seller during performance of the terms of this quotation, shall remain the property of the Seller except by specific stipulation on the face hereof. Seller reserves the right, without liability, for damage or loss, to destroy Buyer's drawings, specifications, patterns and special tools supplied by Buyer for performance of the terms on the face hereof, unless Buyer gives notice of the disposition of such items.

7.5 Return Policy

All returns for credit must be approved in advance by ENMET, LLC. Such returns are subject to a minimum \$50.00 or 20% restocking charge, whichever is greater. **Approval of equipment for return is totally at the discretion of ENMET, LLC.** All requests for return/exchange must be made no later 30 days of the original shipping date from ENMET. The actual amount of any resulting credit will not be determined prior to a complete inspection of the equipment by ENMET. Calibration gas cylinders cannot be returned or restocked.

8.0 Instructions for Returning an Instrument for Service

Contact the ENMET Service Department for all service requests.

Phone: 734-761-1270

Email: repair@enmet.com

Fill out the “Service Request Form” found at the end of this manual and return with your instrument for all needs. Please send your instrument for service to the site in which the product was purchased. A new “Service Request Form” may be requested if the one found in the manual is not available. All instruments should be shipped prepaid to ENMET.

Address for Service:

Michigan Location:

ENMET
Attention: Service Department
680 Fairfield Court
Ann Arbor, MI 48108

Kentucky Location:

ENMET
62 Corporate Court
Bowling Green, KY 42103

Providing the “Service Request Form” assists in the expedient service and return of your unit and failure to provide this information can result in processing delays. **ENMET** charges a one hour minimum billing for all approved repairs with additional time billed to the closest tenth of an hour. All instruments sent to **ENMET** are subject to a minimum evaluation fee, even if returned unrepared. Unclaimed instruments that **ENMET** has received without appropriate paperwork or attempts to advise repair costs that have been unanswered after a period of 60 days may, be disposed of or returned unrepared COD and the customer will be expected to pay the evaluation fee. Serviced instruments are returned by UPS/FedEx Ground and are not insured unless otherwise specified. If expedited shipping methods or insurance is required, it must be stated in your paperwork.

NOTE: *Warranty of customer installed components.*

For Warranty Repairs, please reference **ENMET's** “Warranty Information and Guidelines” (found earlier in this section).

Mailing/Shipping Address:

ENMET
680 Fairfield Court
Ann Arbor, MI 48108
repair@enmet.com



Phone: 734.761.1270
Fax: 734.761.3220

Service Request Form

Product Name or Number:

Product Serial Number:

Describe Problem or Needed Service:

Warranty Claim? Yes No

CUSTOMER INFORMATION

Billing Address:

Shipping Address:

Contact Name:

Phone #:

Email:

Fax #:

PO/Reference

#:

PAYMENT METHOD

COD

VISA/MasterCard

American Express

Card Number

Exp. Date

Security Code:

Name as it Appears on

Card:

RETURN SHIPPING METHOD

UPS Ground

UPS 3 Day
Select

UPS Next Day
Air

UPS ND Air
Saver

UPS 2 Day Air

UPS Account #:

FedEx Ground

FedEx Air
Express Saver

FedEx Air
Overnight Std.

FedEx Air 2
Day

FedEx Air
Overnight P-1

FedEx Account #:

Insure Shipment: Yes No

Insurance \$
Amount: _____