



CP-10
Control Panel
Operation and Maintenance Manual

Table of Contents

1.0 INTRODUCTION	2
1.1 Unpack	2
1.2 Check Order	2
1.3 Serial Numbers.....	2
2.0 COMPONENTS OF THE CP-10	3
2.1 CP-10 elements	3
2.2 CP-10 Operational Features	3
2.3 Circuit Board Features	4
3.0 INSTALLATION OF THE CP-10	5
3.1 Mounting CP-10.....	5
3.1.1 Wiring the CP-10.....	6
3.1.2 Power Supply.....	6
3.2 Sensor/Transmitter Connection.....	7
4.0 OPERATION	9
4.1 Start Up CP-10.....	9
4.1.1 Typical Start Up.....	9
4.2 Normal Display Mode.....	10
4.2.1 Alarm Conditions CP-10.....	10
5.0 MAINTENANCE	11
5.1 Maintenance Menus	11
5.2 CP-10 Maintenance Adjustments.....	14
5.2.1 Exit Maintenance Menu	14
5.2.2 Set Up 4 and 20 Scale.....	14
5.2.3 Alarm Set Points	15
5.2.4 mA Span Set.....	15
7.0 TERMS AND CONDITIONS	17
7.1 Ordering Information	17
7.2 Delivery	17
7.3 Payment Terms	17
7.4 Warranty Information and Guidelines	17
7.5 Return Policy	17
8.0 INSTRUCTIONS FOR RETURNING AN INSTRUMENT FOR SERVICE	18

List of Figures

Figure 1: External CP-10 Features.....	3
Figure 2: CP-10 Circuit Board Features.....	4
Figure 3: Mounting CP-10	5
Figure 4: Power Terminal Connections CP-10	6
Figure 5: Relay Terminal Connections CP-10.....	8
Figure 6: CP-10 Maintenance Menu Flow Chart - Gas	12
Figure 7: CP-10 Maintenance Menu Flow Chart – Oxygen	13

List of Tables

Table 1: Relay Failsafe Settings.....	8
Table 2: CP-10 Maintenance Menus Sequence.....	11

Reference Information:

NOTE: [important information about use of instrument]

CAUTION: [affects equipment – if not followed may cause damage to instrument, sensor etc....]

WARNING: [affects personnel safety – if not followed may cause bodily injury or death.]

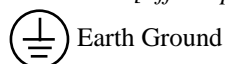

1.0 Introduction

The **CP-10** Control Unit can monitor one channel of gas detection when connected to a Sensor Transmitter(S/T). The **CP-10** is *NOT* in an enclosure rated for use in a Class I, Div. 1, Groups B, C, D classified area and **cannot** be installed in a hazardous location.

Features of the **CP-10**:

- continuous monitoring of the target gas and continuous LCD display of gas and vapor concentrations
- menu driven operational and maintenance controls
- audio and visual alarms indicate unsafe conditions
- alarm relay contacts available on terminals
- a fault relay and visual fault alarm
- alarm acknowledgement capability including audio defeat
- mA outputs for target gas

NOTE: *All specifications stated in this manual may change without notice.*

1.1 Unpack

Unpack the **CP-10** and examine it for shipping damage. If such damage is observed, notify both **ENMET** customer service personnel and the commercial carrier involved immediately.

Regarding Damaged Shipments

NOTE: *It is your responsibility to follow these instructions. If they are not followed, the carrier will not honor any claims for damage.*

- This shipment was carefully inspected, verified and properly packaged at **ENMET** and delivered to the carrier in good condition.
- When it was picked up by the carrier at **ENMET**, it legally became your company's property.
- If your shipment arrives damaged:
 - Keep the items, packing material, and carton "As Is." Within 5 days of receipt, notify the carrier's local office and request immediate inspection of the carton and the contents.
 - After the inspection and after you have received written acknowledgment of the damage from the carrier, contact **ENMET** Customer Service for return authorization and further instructions. Please have your Purchase Order and Sales Order numbers available.
- **ENMET** either repairs or replaces damaged equipment and invoices the carrier to the extent of the liability coverage, usually \$100.00. Repair or replacement charges above that value are your company's responsibility.
- The shipping company may offer optional insurance coverage. **ENMET** only insures shipments with the shipping company when asked to do so in writing by our customer. If you need your shipments insured, please forward a written request to **ENMET** Customer Service.

Regarding Shortages

If there are any shortages or questions regarding this shipment, please notify **ENMET** Customer Service within 5 days of receipt at the following address:

ENMET
680 Fairfield Court
Ann Arbor, MI 48108
734-761-1270 Fax 734-761-3220
Toll Free: 800-521-2978

1.2 Check Order

Check the contents of the shipment against the purchase order. Verify that the **CP-10** is received as ordered. Each **CP-10** is labeled with its target gas. If there are accessories on the order, ascertain that they are present. Check the contents of calibration kits. Notify **ENMET** customer service personnel of any discrepancy immediately.

1.3 Serial Numbers

Each **CP-10** is serialized. These numbers are on tags on the equipment and are on record in an **ENMET** database.

2.0 Components of the CP-10

2.1 CP-10 elements

See Figure 1 for location of elements:

Feature	Description
Enclosure	A polycarbonate box, approximately 7 x 5 x 3, with a detachable front cover. 4 holes for mounting the enclosure to a vertical surface. Located at the corners of the bottom of the enclosure, directly beneath the 4-front cover retaining screws. See Figure 3
Front Cover	Detachable front cover of CP-10 with Display Panel. See Section 2.2 and Figure 1 There are 4 Screws that hold the front cover in place.

2.2 CP-10 Operational Features

The Display Panel is attached by a cable and is released by unscrewing the 4 screws located in the corners. After releasing the panel, it is swung upward, exposing the interior of the enclosure. See **Figure 1** for location of features.

Feature	Description
Display	A single line, 8-character LCD with backlight. Indicates the level of gas detected by sensor. The numerical value of gas concentration and other information is displayed.
Audio Alarm(Horn)	Audio alarm (105 dB at 30cm/12in). The audio alarm is activated when the unit is in alarm.
Visual: Indicators and Alarms	LED indicators: Power / Fault Indicator LED, Green / Red Alarm (3) Indicator LED, Red
Membrane Switches	2 Pushbutton Switches on front panel, control the instrument maintenance functions. The pushbutton switch locations are indicated by: MENU: Advances the instrument display through operation information and maintenance menus SELECT: Disables audio alarm temporarily and Selects the maintenance menu operations. See Section 4.0 and 5.0 for operational and maintenance flow charts.

Three alarm points are preprogrammed into the **CP-10**. At each alarm point, an LED on the front panel is activated. There are 4, 10 Amp relay contacts at each alarm point, plus a fault relay. See Section 3.2 for wiring information.

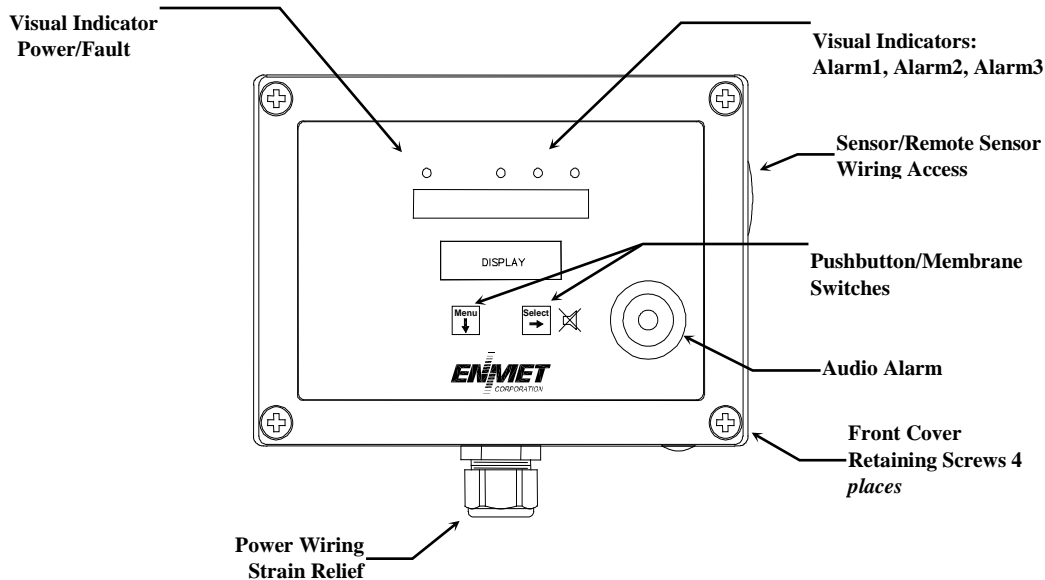

Figure 1: External CP-10 Features

2.3 Circuit Board Features

The Display Panel is attached by a cable and is released by unscrewing the 4 screws located in the corners. After releasing the panel, it is swung upward, exposing the interior of the enclosure. The Circuit Board is mounted at the back surface of the enclosure interior. Features are shown in **Figure 2**.

Feature	Description
Relay Terminals: J14, J15, J16, J17	This group of terminals is located on the Circuit Board. For the contacts for each of three alarm relays, and for the contacts of a fault relay. See Section 3.3
Terminal J12	For VDC back-up power in and the 4-20 mA output. See Section 3.1.2
Sensor Terminal J18	Sensor/Transmitter connection, See Section 3.2
Data Terminal J19	RS-485 input/output
Potentiometer 2, 3 & 4	Not used in CP-10 Do Not Adjust

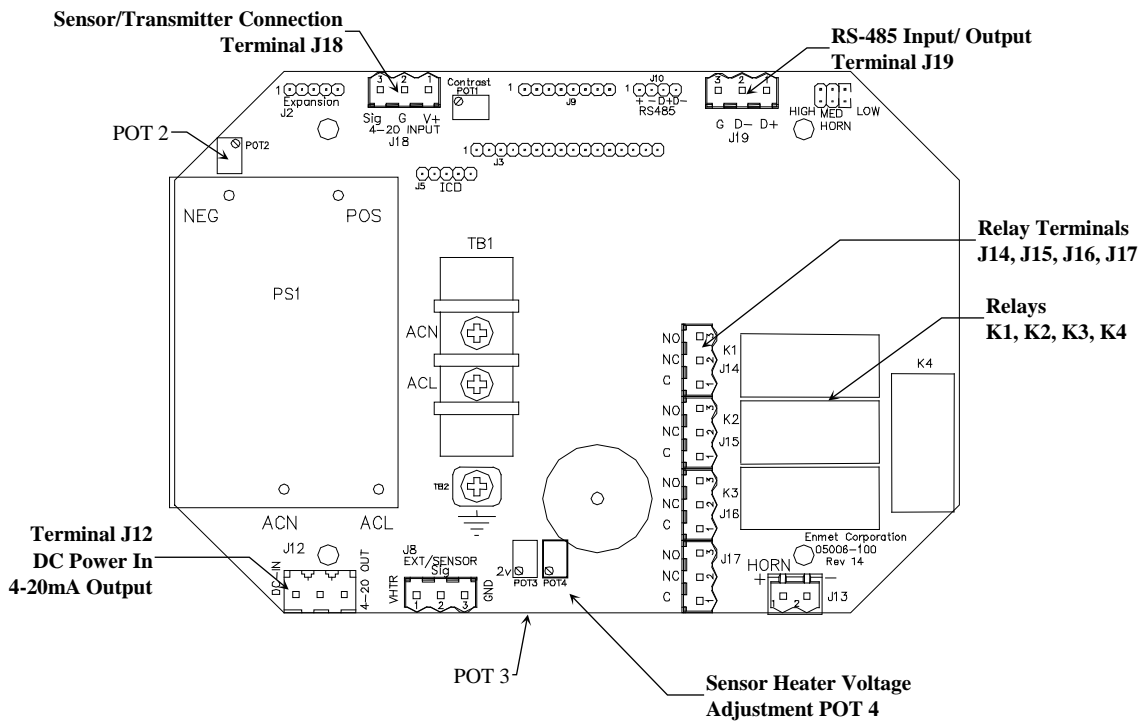

Figure 2: CP-10 Circuit Board Features

3.0 Installation of the CP-10

The CP-10 is supplied with a strain relief for a power line cord. Use this fitting or connect a conduit fitting when supplying power to the unit.

NOTE: This control panel is NOT rated for hazardous locations. The control panel must be in a Non-Hazardous area.

3.1 Mounting CP-10

Mount the CP-10 instrument on an appropriate vertical surface, leaving room for lid to be opened, using the mounting holes provided. Avoid areas with excessive vibration or temperature extremes. The holes in the bottom of the enclosure are 0.18 inch in diameter and form a 6.44" x 4.47" rectangle. See Figure 3

It is recommended to use #8 drywall anchors and screws for mounting the CP-10 to a drywall/sheetrock surface.

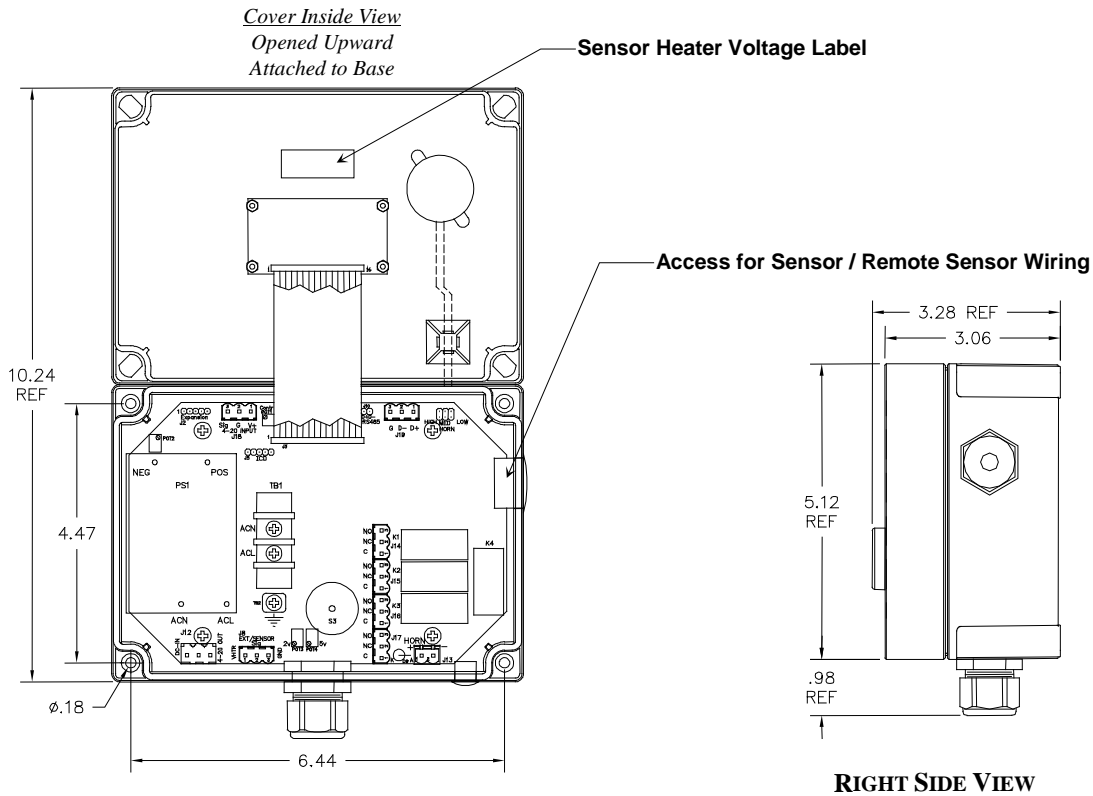

Figure 3: Mounting CP-10

3.1.1 Wiring the CP-10

The electrical installation should conform to appropriate electrical codes, such as the National Electrical Code in the United States.

WARNING: The compliance of the installation to appropriate codes is not ENMET's responsibility.

The CP-10 should be powered through appropriately sized circuit breakers. See Section 6.0 Technical Data.

3.1.2 Power Supply

The input power can vary from 100 to 240 VAC, 50/60 Hz. Power should be connected to the Power Input Terminal **TB1** and the **Ground screw**. See **Figure 4** for location.

For DC wiring 24VDC may be wired to J12, (J12-1) position 1 + with ground connected to (J12-2) position 2.

Upon supplying power to the **CP-10**:

- The green power on LED is lit.
- The display backlight is lit, and instrument will step through a start-up sequence: unit serial number and software revision may be shown on the display.



The instrument may go into alarm briefly, but the sensors stabilize quickly. If the instrument persists in alarm, acknowledge the alarm by pressing the **SELECT** button. If alarm persists longer than 30 minutes, call **ENMET** customer service personnel.

WARNING: Continuous gas detection and alarm systems (110VAC/220VAC / 24VDC/12VDC powered) become inoperative upon loss of primary power. Contact factory for specifications and pricing of backup battery systems.

Sensor/Transmitter Terminal: J18

Position	Function
1, V+	Power +24 VDC
2, G	Power Ground
3, Sig	Signal/Return to Ground

AC Power Supply Terminal: TB1

	Label on PCB	Function
110VAC	TB1 ACN	Neutral
	TB1 ACL	Line
Ground Screw		AC GND
220VAC Optional	TB1 ACN	Neutral
	TB1 ACL	Line
Ground Screw		AC GND

CAUTION: 110/220 VAC when applied

DC Power Supply/4-20mA

Terminal: J12

Position	Function
1 +	24 VDC power
2	GND
3	4 - 20 mA out

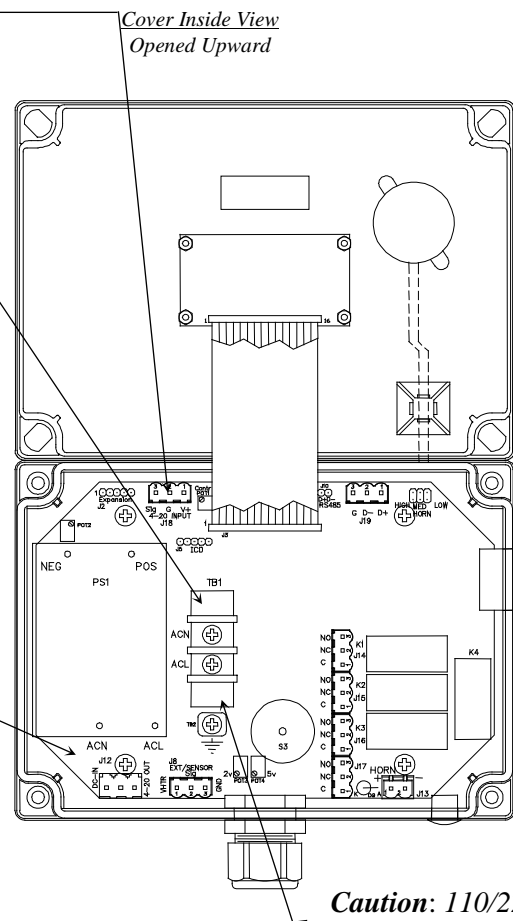

Caution: 110/220 VAC when applied

Figure 4: Power Terminal Connections CP-10

3.2 Sensor/Transmitter Connection

Sensor/Transmitters are connected to the **CP-10** control unit with two or three-conductor wiring, use the correct oil tight fitting. Size of wire depends on the distance between the sensor/transmitter and the control unit. See Recommended Wire Gauge Table below.

2 Wire for Sensors/Transmitter		3 Wire for Sensors/Transmitter	
Position	Function	Position	Function
1, V+	Power +24 VDC	1, V+	Power +24 VDC
2, G	Not Used	2, G	Power Ground
3, Sig	Signal/Return to Ground	3, Sig	Signal

Recommended Wire Gauge

Distance from Sensor to Control Unit	Recommended Wire Gauge
< 500 feet	16 AWG
501 – 800 feet	14 AWG
Longer Distances	Contact Factory

NOTE: Sensor Location

Gases have different densities. Some are heavier than air and concentrate at the bottom of a space. Some are lighter than air and gather at the top. Consider the density of the gas you want the sensor to detect when you install the sensor. Some examples are given below.

Heavier than Air Gas	Sensor Location
Bottled LP (liquefied petroleum)	Interior wall; 18-24" from floor. DO NOT locate directly above or beside gas appliances (ovens, heaters). Avoid locating anywhere near a vent or window or near an outside doorway.
Propane	
Butane	
Gasoline	
Trichloroethylene	
Vaporized hydrocarbons	
Hydrogen sulfide	
Lighter than Air Gas	Sensor Location
Natural gas (methane)	Near ceiling.
Ammonia	DO NOT locate directly above appliances where it is subject to direct exposure to heat or steam.
Hydrogen	
Same Density as Air Gas	Sensor Location
Carbon Monoxide	4-6 feet above the (generally uniform) floor. DO NOT locate in direct air currents of windows, doors, or vents.

If you have a question involving the location of a unit or sensor, please contact your distributor or **ENMET** personnel. A technician will analyze the question and recommend a location.

3.3 Relay Contacts

Relay contacts are available for each alarm; these are SPDT, rated at 10Amp at 110VAC, and may be latching or non-latching as required by the application.

They are accessed on the terminals next to each relay see **Figure 5**. The contact positions are noted on the circuit board next to each terminal.

The following table is for the relays in their un-energized state. This is also the alarm condition state. Non-failsafe configured relays in the alarm state, are the reverse of the PC board labeling. Note that the Fault(FLT) relay cannot be set to operate in a Non-Failsafe mode. Please see **Table 1** below:

Table 1: Relay Failsafe Settings

Alarm	Position	
Alarm 1	J14 (K1) Relay 1 - NO	Normally Open
	J14 (K1) Relay 1 - NC	Normally Closed
	J14 (K1) Relay 1 - COM	Common
Alarm 2	J15 (K2) Relay 2 - NO	Normally Open
	J15 (K2) Relay 2 - NC	Normally Closed
	J15 (K2) Relay 2 - COM	Common
Alarm 3	J16 (K3) Relay 3 - NO	Normally Open
	J16 (K3) Relay 3 - NC	Normally Closed
	J16 (K3) Relay 3 - COM	Common
Fault Alarm	J17 (K4) Relay 4 - NO	Normally Open
	J17 (K4) Relay 4 - NC	Normally Closed
	J17 (K4) Relay 4 - COM	Common

These relay contacts can be used to operate auxiliary alarms or other functions. The relay contacts are DRY, power must be supplied. It is recommended that power for auxiliary equipment be supplied from an independent power source separate from the **CP-10**. Use the existing hole in the enclosure for wire to enter and exit and use appropriate cable fittings. Wiring should be grouped together, VAC wires should be separated for VDC wires.

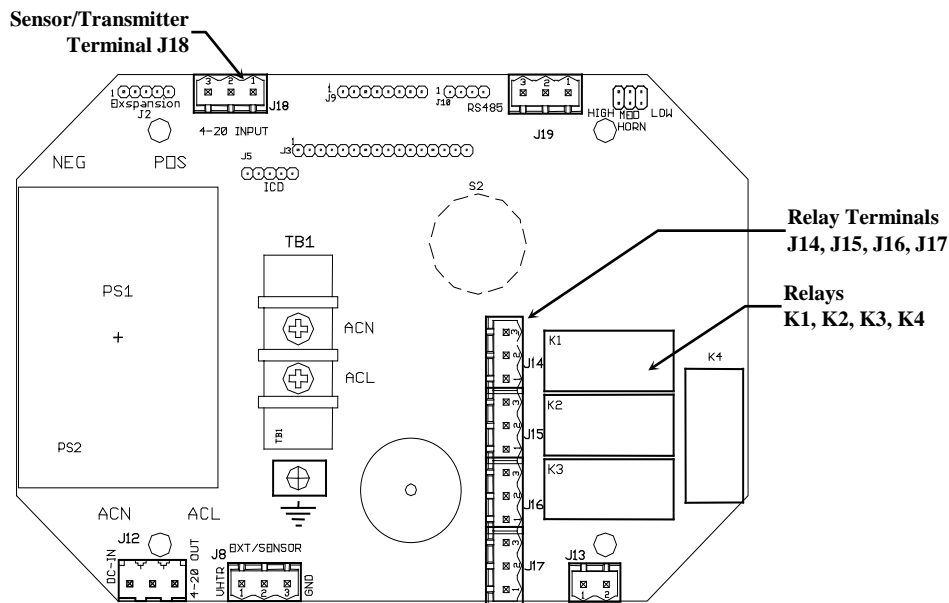

Figure 5: Relay Terminal Connections CP-10

4.0 Operation

When the **CP-10** is installed as described in **Section 3**, and in clean air, the POWER green LED is on, the display is lit and the information on the display is measurement of the target detected by the **CP-10**. The red alarm and fault LEDs are not lit.

4.1 Start Up CP-10

When the **CP-10** is first powered up, it goes through a series of momentary screens, which identify the instrument model number, serial number and software revision. After all the momentary screens have been displayed, the instrument arrives at the Main Gas Display showing the gas concentration and unit of measurement in ppm, % or %LEL.

Depending on transmitter configuration and calibration condition, the furthest right character in the display may flash a letter indicating the instrument status. See the Section 4.1.1 below

4.1.1 Typical Start Up

When power is supplied to the **CP-10**, the instrument will display the following sequence of information:
Typical start up sequence of information displayed.

Example of Typical Start Up Display	Function
CP-10	The instrument: Model CP-10
<i>Example for reference only</i> 130-1256	The instrument: Serial Number
<i>Example for reference only</i> S/W X.X	The instrument: Software Revision
IF the right most character is a flashing W OppW	The instrument is in Warm-up mode This should last about 1 minute The Signal Output is held at 4mA during warm-up
Oppm 20.9% OLEL	The instrument: Normal Display Mode Measurement of the target gas PPM Parts Per Million % Percent by Volume LEL Lower Explosive Limit F Fault, Sensor/Transmitter is not connected or wiring is not correct

NOTE: Software revision may cause variations of display output.

4.2 Normal Display Mode

When the **CP-10** is installed as described in section 3, the POWER green LED is on, the display is lit and the measurement designator: ppm, LEL or % is displayed by the **CP-10**. The red alarm and fault LEDs are not lit.

To advance through displays of operational information press the **MENU** button.

NOTE: *Software revision may cause variations of display output.*

See sequence of operational information below:

Example:

Display Measurement of the target gas
Press **MENU** button

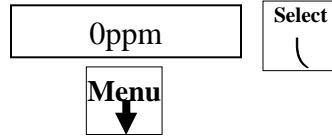

Display indicates Alarm 1 Set point
Press **MENU** button

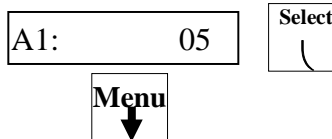

Display indicates Alarm 2 Set point
Press **MENU** button

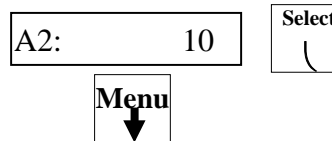

Display indicates Alarm 3 Set point
Press **MENU** button

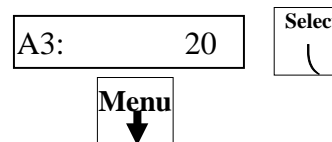

Display indicates mA Span range (Full Scale)
Press **MENU** button

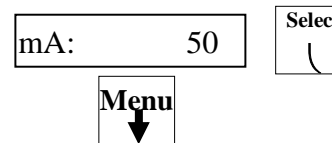

Display returns to gas measurement

Operational Display Flow Chart

4.2.1 Alarm Conditions CP-10

There are three alarm set points available. These alarm points are normally set at established safety levels, such as the OSHA Permissible Exposure Limit (PEL) for toxic gases or recognized standards below the Lower Explosive Limit for combustible gases.

The alarm set points can be changed within limits; see the maintenance section of this manual for the procedure.

When the Oxygen, Toxic or combustible gas concentration reaches the alarm set point, the associated red LED is lit, the associated relay changes state, and the audio alarm is activated.

Pressing the **SELECT** button can temporarily disable the Audio Alarm. The horn will be disabled for about five minutes. If a second alarm condition occurs during this time the horn will re-activate. If the alarm condition(s) have ended during this time the horn will not re-activate.

5.0 Maintenance

The CP-10 maintenance menus that are accessed by pressing the MENU button and SELECT button as described in the maintenance menu section.

5.1 Maintenance Menus





Pushbutton switches control the MENU and SELECT functions. The MENU and SELECT button locations are indicated on the display panel, see Figure 1. The MENU button is used to display the various menu options and make incremental changes to numbers such as alarm points. The SELECT button is used to select the option and move the cursor.

To enter the maintenance menu, press and hold the MENU button for 2 to 4 seconds

Table 2 indicates the maintenance menu sequence see Figure 6 for a detailed maintenance menu flow chart.

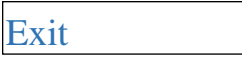
NOTE: Software revision may cause variations of display output.

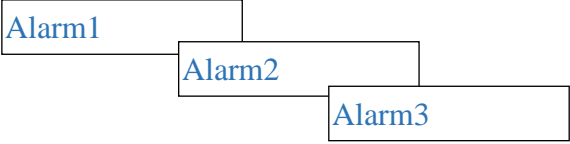
Table 2: CP-10 Maintenance Menus Sequence

Example of Display	Function
 <p>Normal Display Mode</p>	Measurement of CO
Press and hold the MENU button for 2 – 4 seconds to enter the Maintenance Menu The Power/Fault LED will flash Green – Red to indicate the CP-10 is in Maintenance Mode	
	To exit the maintenance Menu and return to the Normal Display Mode: If intended function Press SELECT button
Press the MENU button to advance to 4 & 20 Setup procedures	
	For adjusting the 4 and 20 mA circuit: If Intended function, press SELECT button
Press the MENU button to advance to each Alarm set point procedures	
	For adjusting the Alarm 1, 2 and 3 set points: If Intended function, press SELECT button
Press the MENU button to advance the mA Span set point procedure	
	For adjusting the mA Span set point: If intended function Press SELECT button

Pressing the MENU button without pressing the SELECT button will allow you to cycle through the menu options. You must Press the SELECT button to initiate the desired operation.

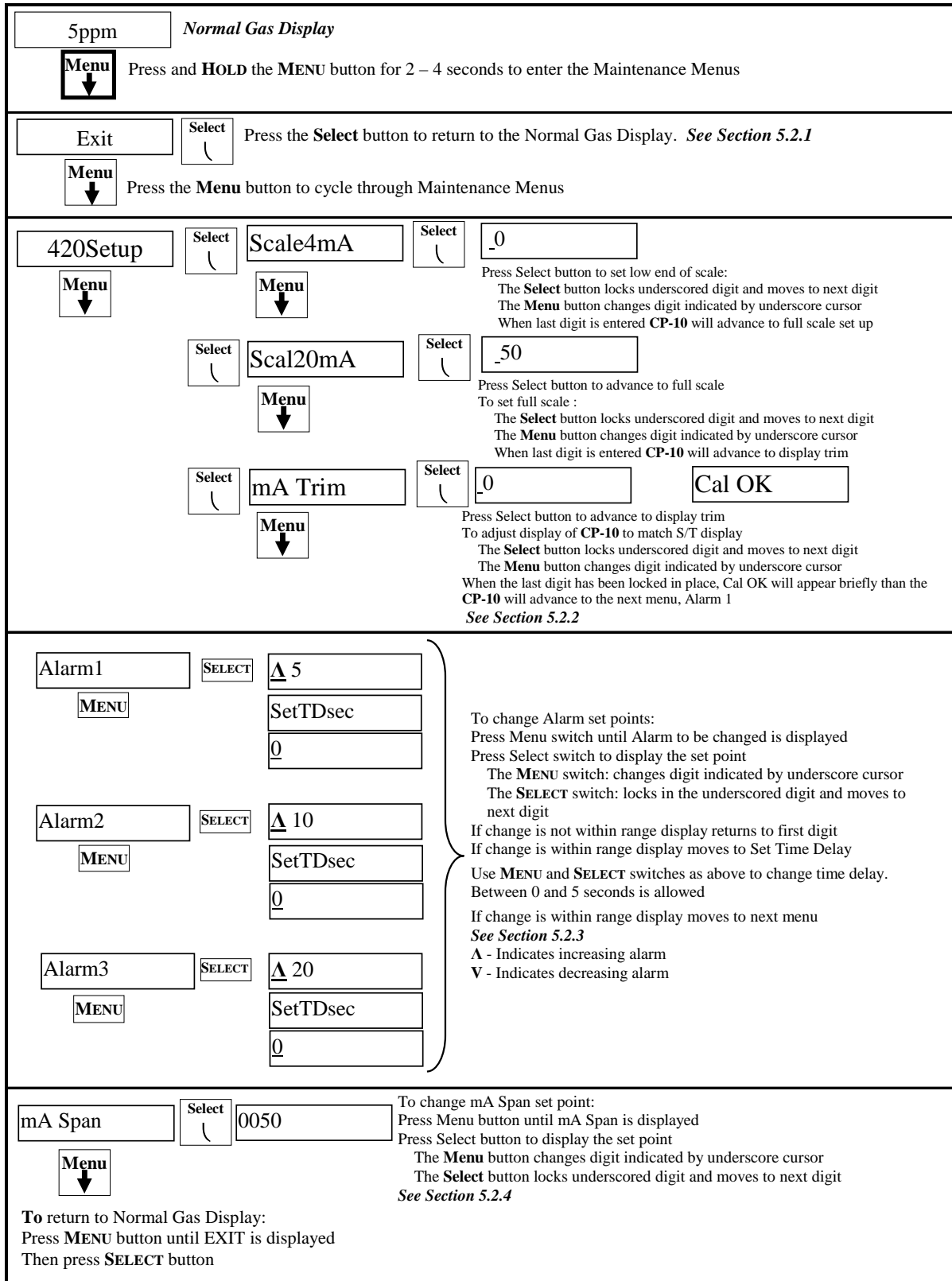

NOTE: Software revision may cause variations of display output.

Figure 6: CP-10 Maintenance Menu Flow Chart - Gas

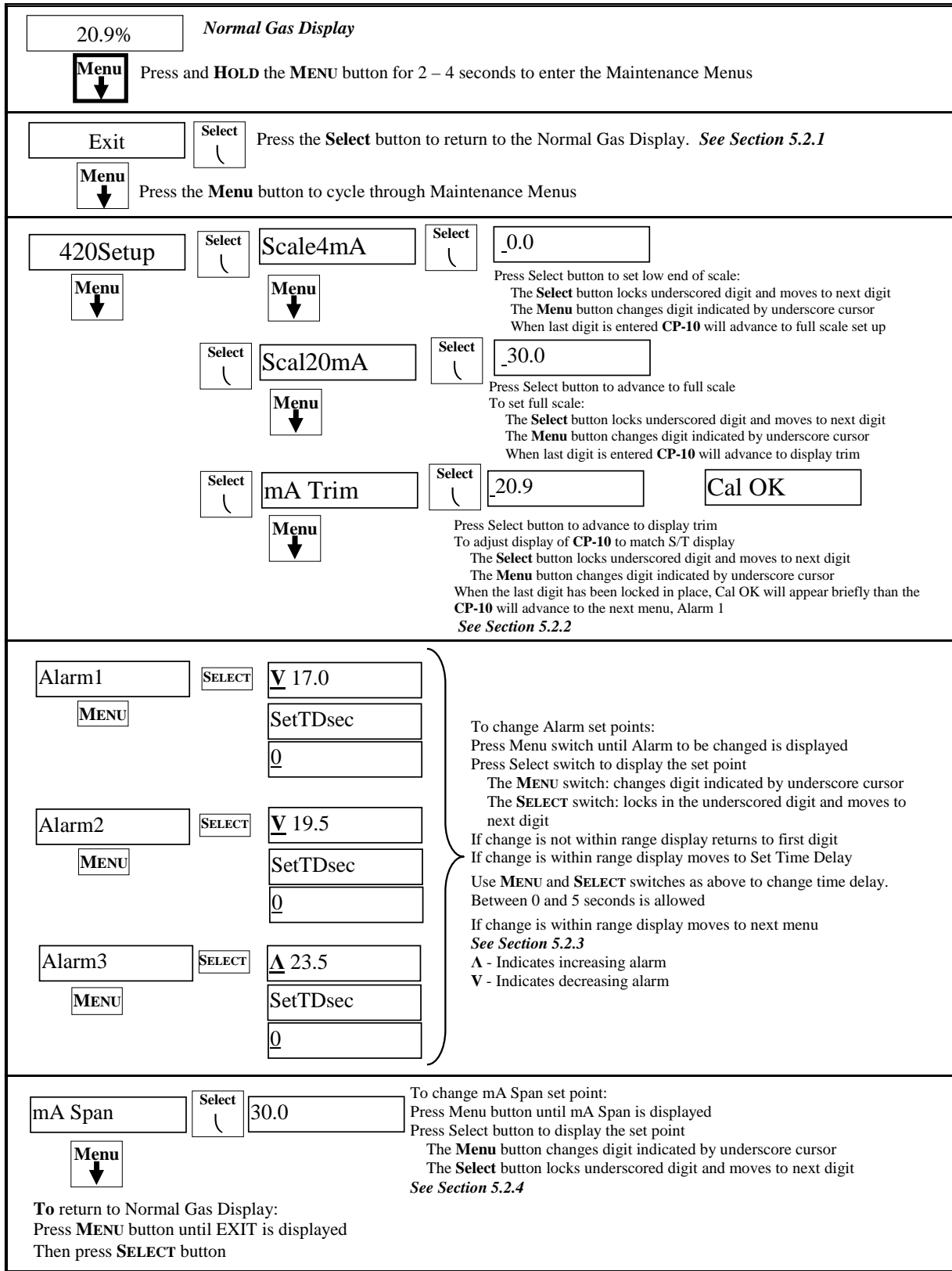

NOTE: Software revision may cause variations of display output.

Figure 7: CP-10 Maintenance Menu Flow Chart – Oxygen

5.2 CP-10 Maintenance Adjustments

To set alarm points and 4-20mA span range enter the **CP-10** maintenance menu.

To enter the maintenance menu, press and **hold** the **MENU** button for 2 to 4 seconds

NOTE: Software revision may cause variations of display output.

5.2.1 Exit Maintenance Menu

Exit maintenance, by pressing the Exit appears on the display. Press the **SELECT** button to return to the instrument Normal Gas Display.

Example of Exit menu:

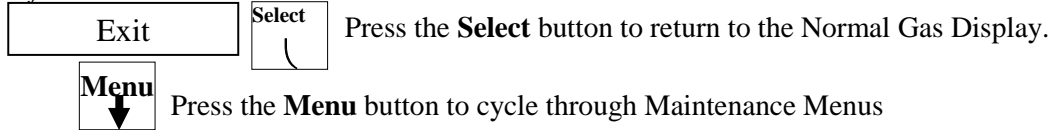

5.2.2 Set Up 4 and 20 Scale

The **CP-10** 4 mA low scale (the low end of range) and 20 mA full scale (the high end of range) is set at the factory. The mA Trim is for the adjustment of minor differences that may occur between the **CP-10** control and the S/T display.

To Set up the low and full scale mA values or the trim of the readings:

Enter the maintenance menu as shown in **Figure 6 & Figure 7 CP-10 Maintenance Menu** flow chart.

1. Press the **MENU** button until to 420Setup is displayed.
2. Press the **SELECT** button to enter 4 mA low end of scale set up.
Note: to advance to the next menu without changing this scale setting Press the **MENU** button
3. Press the **SELECT** button to initiate 4 mA low end of scale set up.
4. Press the **SELECT** button to move the cursor to the next digit.
5. Press the **MENU** button to change the digit indicated by the underscore cursor.
Repeat steps 4 & 5, When last digit is entered the **CP-10** will advance to the next menu.
Note: when mA Trim last digit has been entered, Cal OK will be displayed briefly and **CP-10** will advance to Alarm 1.
6. Press the **MENU** button to advance to the next menu

Example of 4 – 20 mA Scale Setup menus:

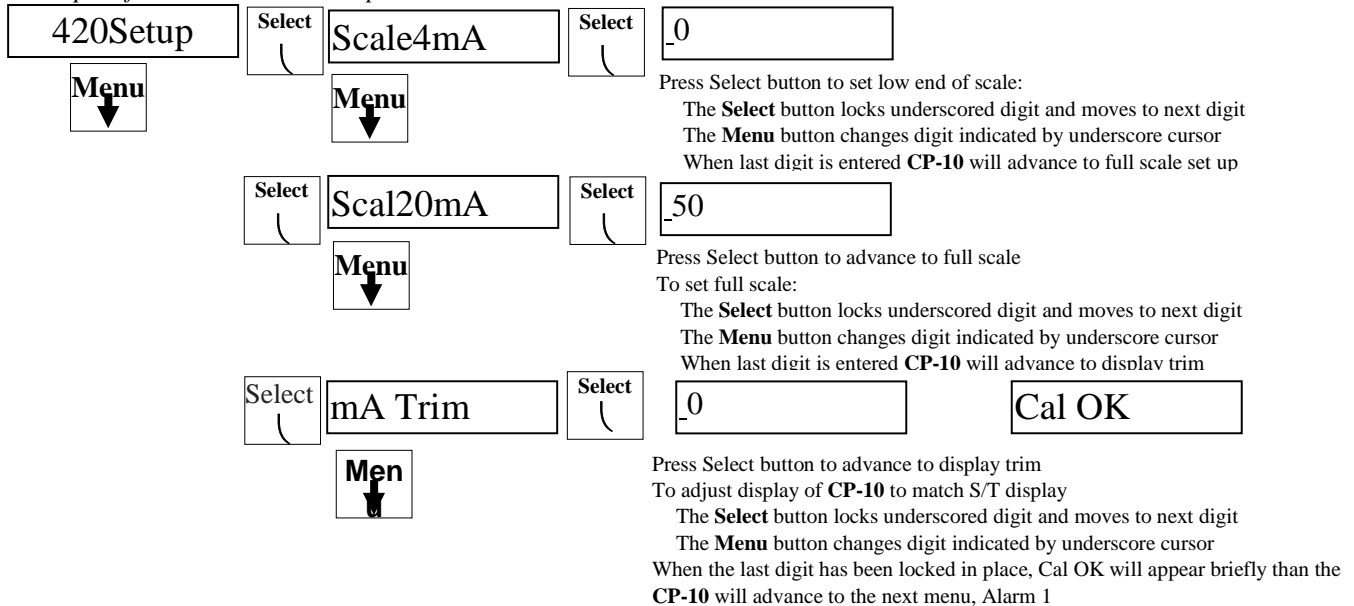

5.2.3 Alarm Set Points

The CP-10 has three alarm set points set at the factory. These alarm points are normally set at established safety levels. Alarm set points can be changed within limits. To change any of the three alarm points:

Enter the maintenance menu as shown in **Figure 6 & Figure 7 CP-10 Maintenance Menu** flow chart.

1. Press the **MENU** button until Alarm1 is displayed.
2. Press the **SELECT** button to initiate alarm set point change
3. Press the **MENU** button to change the digit indicated by the underscore cursor
 Λ - Indicates increasing alarm
 V - Indicates decreasing alarm
4. Press the **SELECT** button to move the cursor to the next digit
 When last digit is entered the CP-10 will advance to the next menu
5. Use **MENU** and **SELECT** switches as above to change time delay. Between 0 and 5 seconds is allowed.
6. Press the **MENU** button to advance to the next menu

NOTE: Alarms 2 and 3 cannot be set below the Alarm 1 setting.

Example of Alarm Set Point menus:

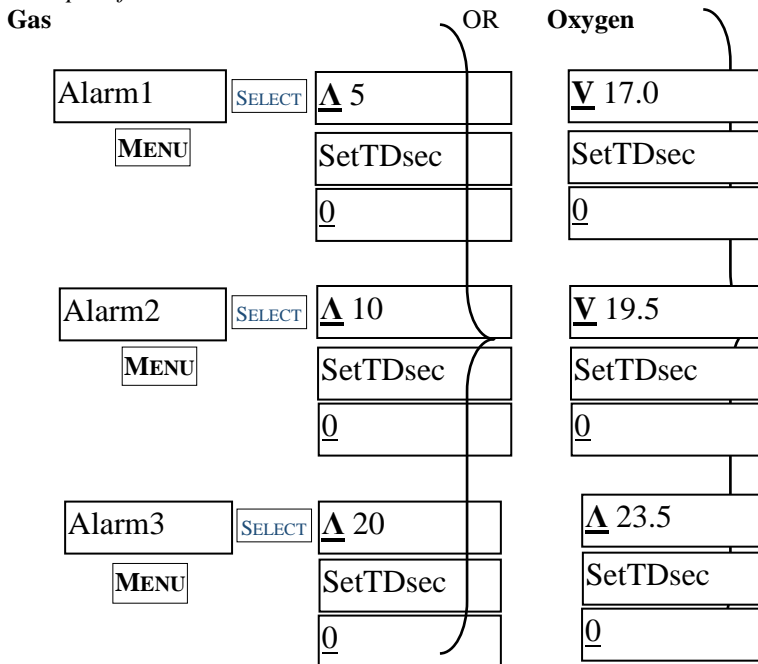

To change Alarm set points:
 Press Menu switch until Alarm to be changed is displayed
 Press Select switch to display the set point
 The **MENU** switch: changes digit indicated by underscore cursor
 The **SELECT** switch: locks in the underscored digit and moves to next digit
 If change is not within range display returns to first digit
 If change is within range display moves to Set Time Delay
 Use **MENU** and **SELECT** switches as above to change time delay.
 Between 0 and 5 seconds is allowed
 If change is within range display moves to next menu

Λ - Indicates increasing alarm
 V - Indicates decreasing alarm

NOTE: Software revision may cause variations of display output.

5.2.4 mA Span Set

The CP-10 4-20mA span range is set at the factory, normally to the full scale of the measurement and can be changed within limits. To change the span range:

Enter the maintenance menu as shown in **Figure 6 CP-10 Maintenance Menu** flow chart.

1. Press the **MENU** button until to display Span is displayed.
2. Press the **SELECT** button to initiate the mA Span menu
3. Press the **MENU** button to change the digit indicated by the underscore cursor
4. Press the **SELECT** button to move the cursor to the next digit
 When last digit is entered the CP-10 will advance to the next menu
5. Press the **MENU** button to advance to the next menu

Example of mA Span menu:

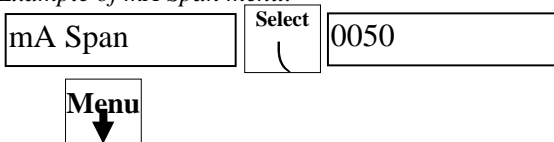

To change mA Span set points:
 Press Menu button until mA Span is displayed
 Press Select button to display the set point
 The **Menu** button changes digit indicated by underscore cursor
 The **Select** button locks underscored digit and moves to next digit

6.0 Technical Data and Specifications

The CP-10 technical data and specifications:

Electrical Power	15 Amp fused branch circuit	
	100-240 VAC	
	0.45A, 50/60 Hz	
	0.6A, 24VDC	
Storage and Transport	Temperature:	-20°C to +60°C (-4°F to +140°F)
	<i>preferred</i>	0°C to +20°C (32°F to 68°F)
	Relative Humidity	10-99% RH, non-condensing
	Atmospheric Pressure	20 to 36 inHg (68 to 133 kPa)
Operation	Temperature:	-15°C to +40°C (5°F to +104°F)
	Relative Humidity	10-99% RH, non-condensing
	Atmospheric Pressure	20 to 36 inHg (68 to 133 kPa)
Mechanical	Dimensions:	7.1 x 5.1 x 3 in(180x130x75mm)
	Weight:	2 lbs (0.9 kg)
	Material:	Polycarbonate
	Strain relief:	0.20 – 0.35 in(5 - 8.8mm)
Outputs	Relays:	SPDT Resistive Load Inductive Load 10A at 110 VAC 7.5A at 110 VAC 10A at 30 VDC 5A at 30 VDC
	Analog:	4-20mA
	Digital:	RS-485-modbus
	Audio:	105 dB at 30cm/12in

NOTE: All specifications stated in this manual may change without notice.

Notes:

7.0 Terms and Conditions

7.1 Ordering Information

Address orders to:

ENMET
Attention: Customer Service Department
680 Fairfield Court
Ann Arbor, MI 48108

Email Orders: orderentry@enmet.com

Phone: 734-761-1270

Fax: 734-761-3220

You may also contact our customer service department by email info@enmet.com. MINIMUM ORDER IS \$50.00.

7.2 Delivery

Unless Seller otherwise specifies, delivery will be made: FOB Ann Arbor, MI and/or FOB Bowling Green, KY. Title and risk of loss shall pass to Buyer at that point. Shipping and handling charges will be Prepaid and Added to Buyer's invoice. Buyer may request shipping be charged to their own account with a preferred carrier. Seller shall have the right to choose means of transportation and to route shipment when specific instructions are not included with Buyer's order. Seller agrees to deliver the goods and services, within the time, in accordance with specifications, at the prices specified on the face hereof. Buyer's orders to this quotation are not subject to cancellation or deferment of delivery without indemnification of loss to the Seller resulting there from. Seller shall not be liable to Buyer for any loss or damage sustained on account of this delay or nonperformance due to causes beyond Seller's control and without his fault or negligence. Where performance of the terms here is contingent upon timely delivery of goods or services by the Buyer and such delivery is in default, Seller shall be indemnified for any damage or loss resulting there from, and/or by extension of Seller's delivery commitment, as applicable.

7.3 Payment Terms

Payment Terms are Net 30 Days from the date of shipment from Seller unless otherwise noted. All shipping and handling costs will be charged to Buyer on a Prepaid and Add basis. Buyer has the option of paying for shipping by charging its own account with a carrier

7.4 Warranty Information and Guidelines

The Seller warrants new instruments to be free from defects in workmanship and material under normal use for a period of one year from date of shipment. The warrant covers both parts and labor excluding calibration and expendable parts such as filters, detector tubes, batteries, etc. If the inspection by the Seller confirms that the product is defective, it will be repaired or replaced at no charge, within the stated limitations, and returned prepaid to any location in the United States. The Seller shall not be liable for any loss or damage caused by the improper use or installation of the product. The Buyer indemnifies and saves harmless the Seller with respect to any loss or damages that may arise through the use by the Buyer or others of this equipment. This warranty is expressly given in lieu of all other warranties, either expressed, implied or statutory, including that of merchantability, and all other obligations, or liabilities of ENMET, LLC for damages arising out of or in connection with the use or repair or performance of the product. In no event shall ENMET, LLC, be liable for any indirect, incidental, special or consequential damages or for any delay in the performance by ENMET, LLC, which may arise in connection with this equipment. ENMET neither assumes nor authorizes any representatives or other persons to assume for it any obligation or liability other than that which is set forth herein. Buyer agrees to indemnify and save harmless Seller for any damage or loss from lawsuits against Seller by reason of manufacture of sale of materials, parts, or use of processes resulting from Buyer's design specifications. Any patent, design, pattern, tool, die, jig, fixture, drawing, test equipment, or process furnished by Seller; whether possessed by the Seller before the date of this quotation, or devised or acquired by Seller during performance of the terms of this quotation, shall remain the property of the Seller except by specific stipulation on the face hereof. Seller reserves the right, without liability, for damage or loss, to destroy Buyer's drawings, specifications, patterns and special tools supplied by Buyer for performance of the terms on the face hereof, unless Buyer gives notice of the disposition of such items.

7.5 Return Policy

All returns for credit must be approved in advance by ENMET, LLC. Such returns are subject to a minimum \$50.00 or 20% restocking charge, whichever is greater. **Approval of equipment for return is totally at the discretion of ENMET, LLC.** All requests for return/exchange must be made no later 30 days of the original shipping date from ENMET. The actual amount of any resulting credit will not be determined prior to a complete inspection of the equipment by ENMET. Calibration gas cylinders cannot be returned or restocked.

8.0 Instructions for Returning an Instrument for Service

Contact the ENMET Service Department for all service requests.

Phone: 734-761-1270

Email: repair@enmet.com

Fill out the “Service Request Form” found at the end of this manual and return with your instrument for all needs. Please send your instrument for service to the site in which the product was purchased. A new “Service Request Form” may be requested if the one found in the manual is not available. All instruments should be shipped prepaid to ENMET.

Address for Service:

Michigan Location:

ENMET
Attention: Service Department
680 Fairfield Court
Ann Arbor, MI 48108

Kentucky Location:

ENMET
62 Corporate Court
Bowling Green, KY 42103

Providing the “Service Request Form” assists in the expedient service and return of your unit and failure to provide this information can result in processing delays. **ENMET** charges a one hour minimum billing for all approved repairs with additional time billed to the closest tenth of an hour. All instruments sent to **ENMET** are subject to a minimum evaluation fee, even if returned unrepared. Unclaimed instruments that **ENMET** has received without appropriate paperwork or attempts to advise repair costs that have been unanswered after a period of 60 days may, be disposed of or returned unrepared COD and the customer will be expected to pay the evaluation fee. Serviced instruments are returned by UPS/FedEx Ground and are not insured unless otherwise specified. If expedited shipping methods or insurance is required, it must be stated in your paperwork.

NOTE: *Warranty of customer installed components.*

For Warranty Repairs, please reference **ENMET's** “Warranty Information and Guidelines” (found earlier in this section).

Mailing/Shipping Address:

ENMET
680 Fairfield Court
Ann Arbor, MI 48108
repair@enmet.com



Phone: 734.761.1270
Fax: 734.761.3220

Service Request Form

Product Name or Number:

Product Serial Number:

Describe Problem or Needed Service:

Warranty Claim? Yes No

CUSTOMER INFORMATION

Billing Address:

Shipping Address:

Contact Name: _____

Phone #: _____

Email: _____

Fax #: _____

PO/Reference #: _____

PAYMENT METHOD

COD VISA/MasterCard American Express

Card Number

Exp. Date

Security Code:

Name as it Appears on

Card: _____

RETURN SHIPPING METHOD

UPS Ground UPS 3 Day Select UPS Next Day Air UPS ND Air Saver UPS 2 Day Air

UPS Account #: _____

FedEx Ground FedEx Air Express Saver FedEx Air Overnight Std. FedEx Air 2 Day FedEx Air Overnight P-1

FedEx Account #: _____

Insure Shipment: Yes No

Insurance \$
Amount: _____