

ENMET

680 Fairfield Court
Ann Arbor, MI 48108
734.761.1270 Fax 734.761.3220
www.enmet.com

ENMET
Creative Gas Detection Solutions



**AM-5150
Ambient Air Monitor
Operation and Maintenance Manual**

Table of Contents

1.0 INTRODUCTION	3
1.1 Unpack.....	3
1.2 Check Order.....	3
1.3 Serial Numbers.....	3
2.0 COMPONENTS OF THE AM-5150	4
2.1 AM-5150 elements.....	4
2.2 AM-5150 Operational Features.....	4
2.3 Circuit Board Features.....	5
3.0 INSTALLATION OF THE AM-5150	6
3.1 Mounting AM-5150.....	6
3.1.1 Wiring the AM-5150.....	6
3.1.2 Power Supply.....	6
3.2 Sensor Location.....	7
3.3 Relay Contacts.....	9
4.0 OPERATION	10
4.1 Start Up AM-5150.....	10
4.1.1 Typical Start Up.....	10
4.2 Normal Display Mode.....	11
4.2.1 Alarm Conditions AM-5150.....	11
5.0 MAINTENANCE	12
5.1 Maintenance Menus.....	12
5.2 Calibration of the AM-5150.....	14
5.2.1 Exit Maintenance Menu.....	15
5.2.2 Zero Adjust.....	15
5.2.3 Gas Span.....	16
5.2.4 Alarm Set Points.....	17
5.2.5 mA Span Set.....	17
5.3 Sensor Replacement.....	18
5.3.1 Sensor Replacement Calibration.....	19
6.0 ACCESSORY AND REPLACEMENT PARTS	20
7.0 TECHNICAL DATA AND SPECIFICATIONS	20
8.0 TERMS AND CONDITIONS	22
8.1 Ordering Information.....	22
8.2 Delivery.....	22
8.3 Payment Terms.....	22
8.4 Warranty Information and Guidelines.....	22
8.5 Return Policy.....	22
9.0 INSTRUCTIONS FOR RETURNING AN INSTRUMENT FOR SERVICE	23

List of Figures

Figure 1: External AM-5150 Features	4
Figure 2: AM-5150 Circuit Board Features	5
Figure 3: Mounting AM-5150	6
Figure 4: Power Terminal Connections AM-5150.....	7
Figure 5: Internal View of Sensor Wiring	8
Figure 6: Relay Terminal Connections AM-5150	9
Figure 7: AM-5150 Maintenance Menu Flow Chart	13
Figure 8: Calibration Adapter	14
Figure 9: AM-5150 Sensor Replacement	18

List of Tables

Table 1: Relay Failsafe Settings	9
Table 2: AM-5150 Maintenance Menu Sequence	12

Reference Information:

NOTE: *[important information about use of instrument]*

CAUTION: *[affects equipment – if not followed may cause damage to instrument, sensor etc....]*

WARNING: *[affects personnel safety – if not followed may cause bodily injury or death.]*



Attention / Warning



Earth Ground

1.0 Introduction

The AM-5150 is an ambient air monitoring instrument that measures and detects gases utilizing a non-specific MOS sensor. The AM-5150 is NOT in an enclosure rated for use in a Class I, Div. 1, Groups B, C, D classified area and cannot be installed in a hazardous location. However, the remote sensor housing and sensor are rated for Class I, Div. 1, Groups A, B, C & D hazardous locations and may be installed in such locations with appropriate wiring.

Features of the AM-5150:

- continuous monitoring of the ambient air and continuous LCD display of gas and vapor concentrations
- menu driven operational and maintenance controls
- menu driven calibration procedure
- audio and visual alarms indicate unsafe conditions
- alarm relay contacts available on terminals
- a fault relay and visual fault alarm
- alarm acknowledgement capability including audio defeat
- mA outputs for target gas

NOTE: *All specifications stated in this manual may change without notice.*

1.1 Unpack

Unpack the **AM-5150** and examine it for shipping damage. If such damage is observed, notify both **ENMET** customer service personnel and the commercial carrier involved immediately.

Regarding Damaged Shipments

NOTE: *It is your responsibility to follow these instructions. If they are not followed, the carrier will not honor any claims for damage.*

- This shipment was carefully inspected, verified and properly packaged at **ENMET** and delivered to the carrier in good condition.
- When it was picked up by the carrier at **ENMET**, it legally became your company's property.
- If your shipment arrives damaged:
 - Keep the items, packing material, and carton "As Is." Within 5 days of receipt, notify the carrier's local office and request immediate inspection of the carton and the contents.
 - After the inspection and after you have received written acknowledgment of the damage from the carrier, contact **ENMET** Customer Service for return authorization and further instructions. Please have your Purchase Order and Sales Order numbers available.
- **ENMET** either repairs or replaces damaged equipment and invoices the carrier to the extent of the liability coverage, usually \$100.00. Repair or replacement charges above that value are your company's responsibility.
- The shipping company may offer optional insurance coverage. **ENMET** only insures shipments with the shipping company when asked to do so in writing by our customer. If you need your shipments insured, please forward a written request to **ENMET** Customer Service.

Regarding Shortages

If there are any shortages or questions regarding this shipment, please notify **ENMET** Customer Service within 5 days of receipt at the following address:

ENMET
680 Fairfield Court
Ann Arbor, MI 48108
734-761-1270 Fax 734-761-3220
Toll Free: 800-521-2978

1.2 Check Order

Check, the contents of the shipment against the purchase order. Verify that the **AM-5150** is received as ordered. Each **AM-5150** is labeled with its target gas. If there are accessories on the order, ascertain that they are present. Check the contents of calibration kits. Notify **ENMET** customer service personnel of any discrepancy immediately.

1.3 Serial Numbers

Each **AM-5150** is serialized. These numbers are on tags on the equipment and are on record in an **ENMET** database.

2.0 Components of the AM-5150

2.1 AM-5150 elements

See Figure 1 for location of elements:

Feature	Description
Enclosure	A polycarbonate box, approximately 7 x 5 x 3, with a detachable front cover. 4 holes for mounting the enclosure to a vertical surface. Located at the corners of the bottom of the enclosure, directly beneath the 4-front cover retaining screws. See Figure 3
Front Cover	Detachable front cover of AM-5150 with Display Panel. See Section 2.2 and Figure 1 There are 4 Screws that hold the front cover in place.

2.2 AM-5150 Operational Features

The Display Panel is attached by a cable and is released by unscrewing the 4 screws located in the corners. After releasing the panel, it is swung upward, exposing the interior of the enclosure. See **Figure 1** for location of features.

Feature	Description
Display	A single line, 8-character LCD with backlight. Indicates the level of gas detected by sensor. The numerical value of gas concentration and other information is displayed.
Audio Alarm(Horn)	Audio alarm (105 dB at 30cm/12in). The audio alarm is activated when the unit is in alarm.
Visual: Indicators and Alarms	LED indicators: Power / Fault Indicator LED, Green / Red Alarm (3) Indicator LED, Red
Membrane Switches	2 Pushbutton Switches on front panel control the instrument maintenance functions. The pushbutton switch locations are indicated by: MENU ↓: Advances the instrument display through operation information and maintenance menus SELECT →: Disables audio alarm temporarily and Selects the maintenance menu operations such as, Zero, Span, Exit menu or sets proper calibration values for Zero or Span See Section 4.0 and 5.0 for operational and maintenance flow charts.

Three alarm points are preprogrammed into the AM-5150. At each alarm point, an LED on the front panel is activated. There are 4, 10 Amp relay contacts at each alarm point, plus a fault relay. See Section 3.2 for wiring information.

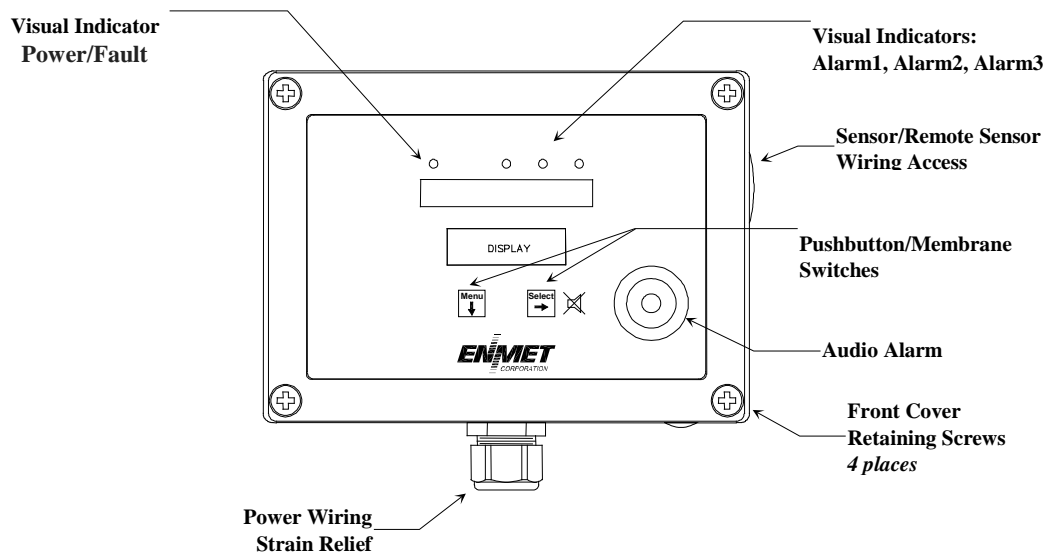

Figure 1: External AM-5150 Features

2.3 Circuit Board Features

The Display Panel is attached by a cable and is released by unscrewing the 4 screws located in the corners. After releasing the panel, it is swung upward, exposing the interior of the enclosure. The Circuit Board is mounted at the back surface of the enclosure interior. Features are shown in **Figure 2**.

Feature	Description
Relay Terminals: J14, J15, J16, J17	This group of terminals is located on the Circuit Board. For the contacts of each of three alarm relays, and for the contacts of a fault relay. See Section 3.3
Terminal J12	For VDC back-up power in and the 4-20 mA output. See Section 3.1.2
Sensor Terminal J8	Sensor connection, See Section 3.2
Data Terminal J19	RS-485 input/output
Potentiometer 4	Sensor heater voltage adjustment, See Section 3.2.1
Potentiometer 2 & 3	Not used in AM-5150 Do Not Adjust

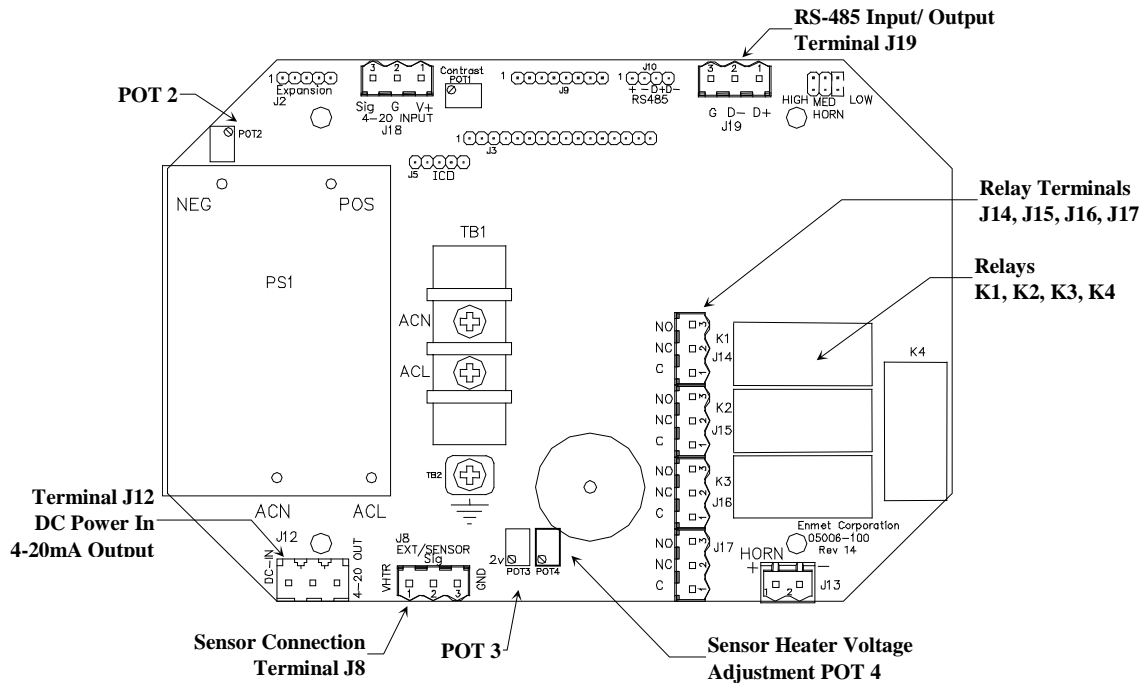

Figure 2: AM-5150 Circuit Board Features

3.0 Installation of the AM-5150

The **AM-5150** is supplied with a strain relief for a power line cord. Use this fitting or connect a conduit fitting when supplying power to the unit.

NOTE: This control panel is *NOT* rated for hazardous locations. The control panel must be in a Non-Hazardous area.

3.1 Mounting AM-5150

Mount the **AM-5150** instrument on an appropriate vertical surface, leaving room for lid to be opened, using the mounting holes provided. Avoid areas with excessive vibration or temperature extremes. The holes in the bottom of the enclosure are 0.18 inch in diameter and form a 6.44" x 4.47" rectangle. **See Figure 3**

It is recommended to use #8 drywall anchors and screws for mounting the **AM-5150** to a drywall/sheetrock surface.

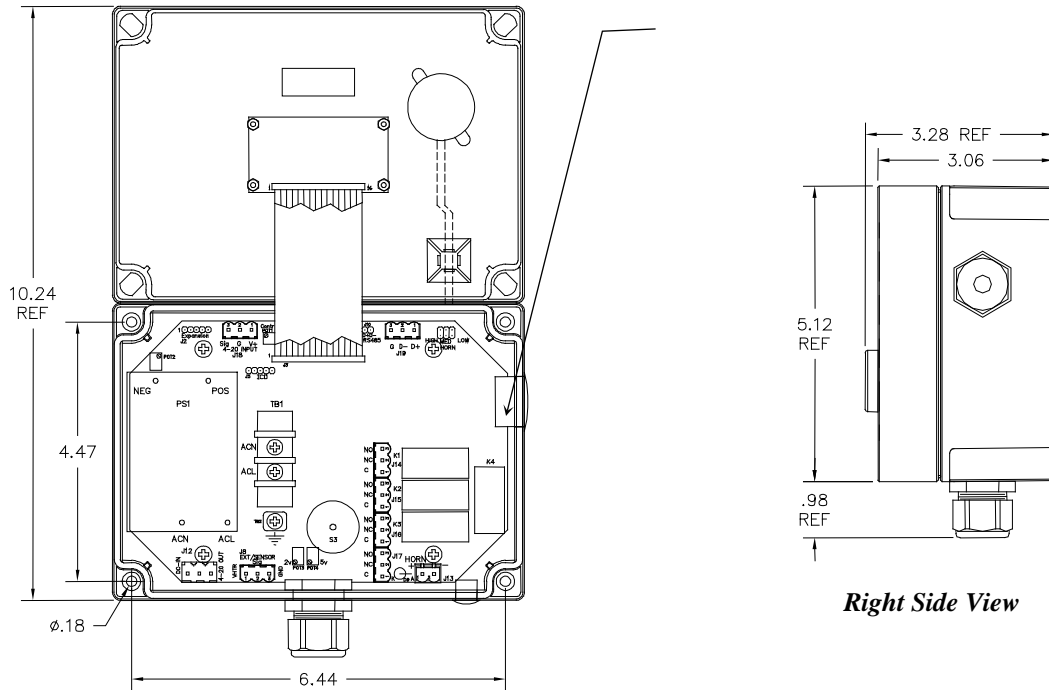

Figure 3: Mounting AM-5150

3.1.1 Wiring the AM-5150

The electrical installation should conform to appropriate electrical codes, such as the National Electrical Code in the United States.

WARNING: The compliance of the installation to appropriate codes is not **ENMET**'s responsibility.

The **AM-5150** should be powered through circuit breakers provided for this purpose.

3.1.2 Power Supply

The input power can vary from 100 to 240 VAC, 50/60 Hz. Power should be connected to the Power Input Terminal **TB1** and the **Ground screw**. See **Figure 4** for location.

For DC wiring 24VDC may be wired to J12, (J12-1) position 1 + with ground connected to (J12-2) position 2.



Upon supplying power to the **AM-5150**:

- The green power on LED is lit.
- The display backlight is lit, and instrument will step through a start-up sequence: unit serial number and software revision may be shown on the display.

The instrument may go into alarm briefly, but the sensors stabilize quickly. If the instrument persists in alarm, acknowledge the alarm by pressing the **SELECT** button. If alarm persists longer than 30 minutes, call **ENMET** customer service personnel.

WARNING: Continuous gas detection and alarm systems (110VAC/220VAC / 24VDC/12VDC powered) become inoperative upon loss of primary power. Contact factory for specifications and pricing of backup battery systems.

AC Power Supply Terminal: TB1

	Label on PCB	Function
110VAC	TB1 ACN	Neutral
	TB1 ACL	Line
		AC GND
Ground Screw		
220VAC	TB1 ACN	Neutral
	TB1 ACL	Line
		AC GND
Optional Ground Screw		

CAUTION: 110/220 VAC when applied

**DC Power Supply/4-20mA
Terminal: J12**

Position	Function
1 +	24 VDC power
2	GND
3	4 - 20 mA out

Sensor Terminal: J8

Position	Function	Color
1	Heater	Orange
2	Signal	Blue
3	Ground	2 wires, Brown & Yellow

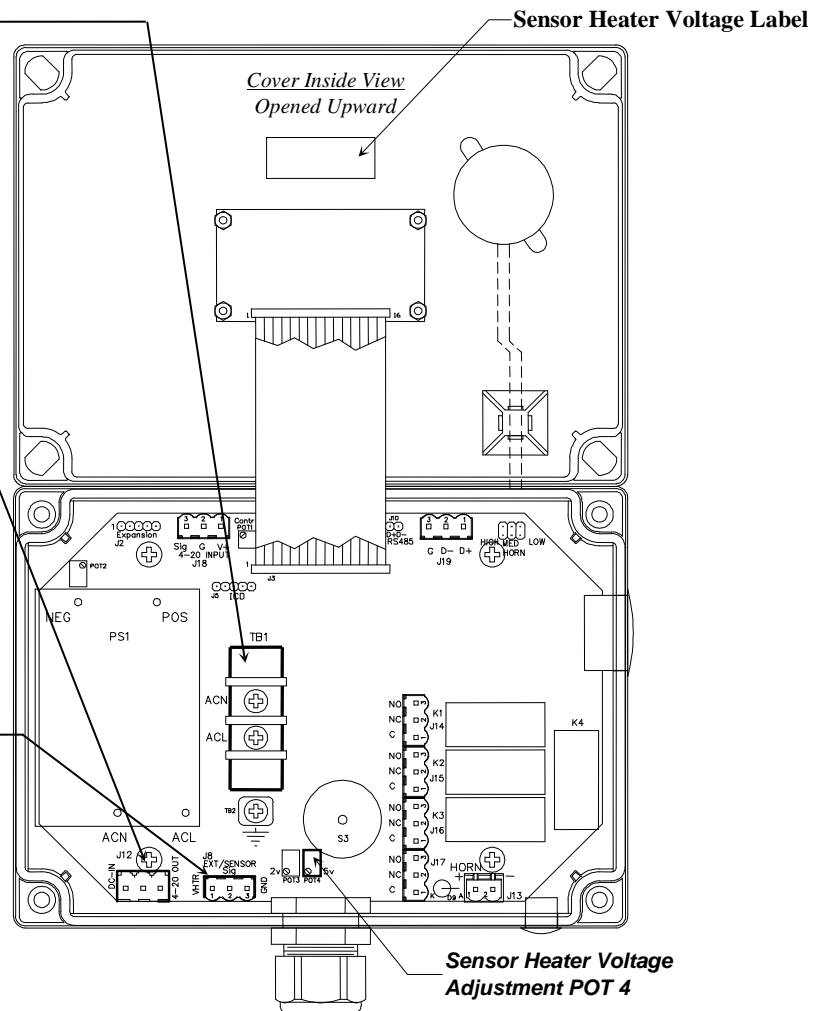

Figure 4: Power Terminal Connections AM-5150

3.2 Sensor Location

Gases have different densities. Some are heavier than air and concentrate at the bottom of a space. Some are lighter than air and gather at the top. Consider the density of the gas you want the sensor to detect when you install the sensor. Some examples are given below.

Heavier than Air Gas	Sensor Location
Bottled LP (liquefied petroleum)	Interior wall; 18-24" from floor. Do NOT locate directly above or beside gas appliances (ovens, heaters). Avoid locating anywhere near a vent or window or near an outside doorway.
Propane	
Butane	
Gasoline	
Trichloroethylene	
Vaporized hydrocarbons	
Hydrogen sulfide	
Lighter than Air Gas	Sensor Location
Natural gas (methane)	Near ceiling. Do NOT locate directly above appliances where it is subject to direct exposure to heat or steam.
Ammonia	
Hydrogen	
Same Density as Air Gas	Sensor Location
Carbon Monoxide	4-6 feet above the (generally uniform) floor. Do NOT locate in direct air currents of windows, doors, or vents.

If you have a question involving the location of a unit or sensor, please contact your distributor or **ENMET** personnel. A technician will analyze the question and recommend a location.

3.2.1 Sensor Hook-up

The MOS sensor is connected to the **AM-5150** control unit with four-conductor wiring, use the correct oil tight fitting. Two conductors supply heater voltage and heater ground for the sensor. The third and fourth conductors are signal and signal ground wires. Size of the wire depends on the distance between the sensor and the control unit.

Recommended Wire Gauge

Sensor Type	Distance from Sensor to Control Unit	Recommended Wire Gauge
High Voltage: 812, 813, 826, etc.	≤ 500 feet	16 AWG
	501 – 800 feet	14 AWG
	Longer Distances	Contact <i>ENMET</i> Corp
Low Voltage: 109	≤ 50 feet	16 AWG
	Longer Distances	Contact <i>ENMET</i> Corp

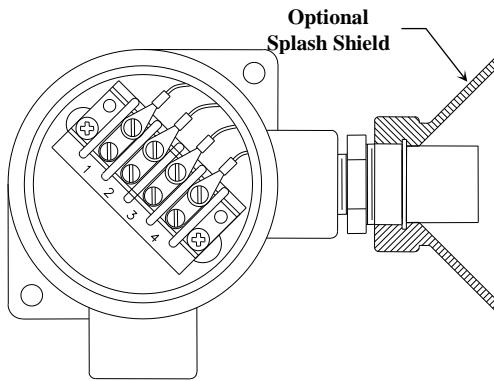

Wiring for 4-wire Terminal Sensors

Position	Function	Wire Color
1	Heater	Orange
2	Signal	Blue
3	Heater Ground	Brown
4	Signal Ground	Yellow

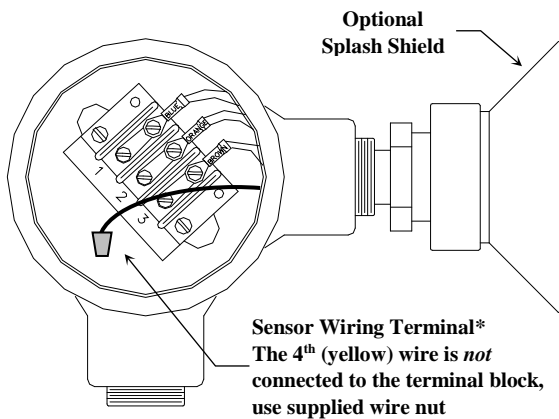

Wiring for 3-wire Terminal Sensors

Position	Function	Wire Color
1	Heater	Orange
2	Signal	Blue
3	Heater Ground	Brown
Wire Nut	Signal Ground	Yellow

NOTE: The yellow signal wire is *not* connected to the terminal block, use supplied wire nut.

Figure 5: Internal View of Sensor Wiring

Wire length between the **AM-5150** and the sensor greater than 100ft will require that the sensor heater voltage be reset. After you mount and install the **AM-5150** and Sensor, you must verify the sensor heater voltage. Use position 2 and 3 to measure heater voltage.

Locate the sensor heater voltage table label inside the instrument, see **Figure 4**. Measure the sensor heater voltage at the sensor, see **Figure 5** and adjust the heater adjustment POT 4 until required voltage is reached, see **Figure 4**.

3.3 Relay Contacts

Relay contacts are available for each alarm; these are SPDT, rated at 10Amp at 110VAC, and may be latching or non-latching as required by the application.

They are accessed on the terminals next to each relay see **Figure 6**. The contact positions are noted on the circuit board next to each terminal.

The following table is for the relays in their un-energized state. This is also the alarm condition state. Non-failsafe configured relays in the alarm state, are the reverse of the PC board labeling. Note that the Fault(FLT) relay cannot be set to operate in a Non-Failsafe mode. Please see **Table 1** below:

Table 1: Relay Failsafe Settings

Alarm	Position	
Alarm 1	J14 (K1) Relay 1 - NO	Normally Open
	J14 (K1) Relay 1 - NC	Normally Closed
	J14 (K1) Relay 1 - COM	Common
Alarm 2	J15 (K2) Relay 2 - NO	Normally Open
	J15 (K2) Relay 2 - NC	Normally Closed
	J15 (K2) Relay 2 - COM	Common
Alarm 3	J16 (K3) Relay 3 - NO	Normally Open
	J16 (K3) Relay 3 - NC	Normally Closed
	J16 (K3) Relay 3 - COM	Common
Fault Alarm	J17 (K4) Relay 4 - NO	Normally Open
	J17 (K4) Relay 4 - NC	Normally Closed
	J17 (K4) Relay 4 - COM	Common

These relay contacts can be used to operate auxiliary alarms or other functions. The relay contacts are DRY, power must be supplied. It is recommended that power for auxiliary equipment be supplied from an independent power source separate from the **AM-5150**. Use the existing hole in the enclosure for wire to enter and exit and use appropriate cable fittings. Wiring should be grouped together, VAC wires should be separated for VDC wires.

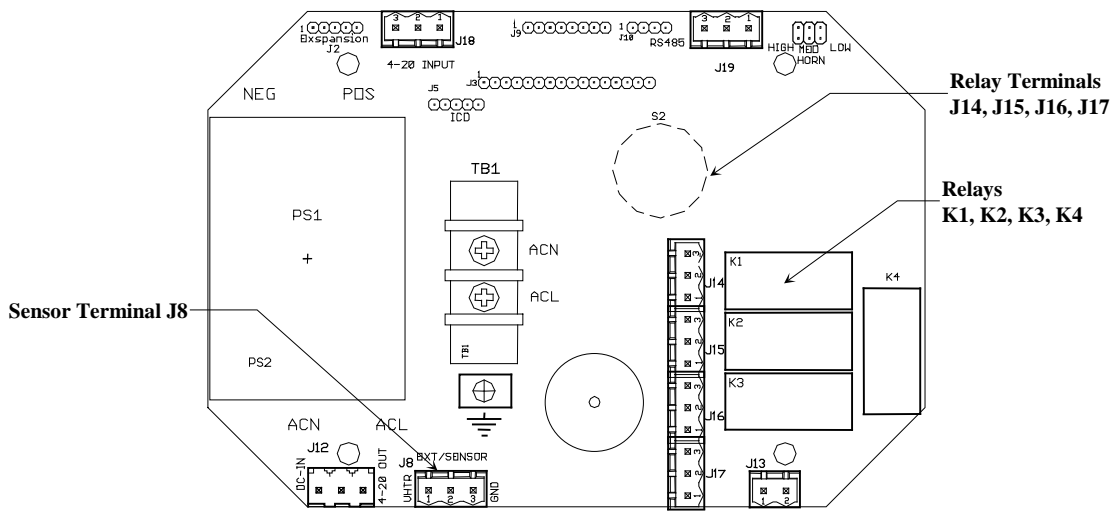

Figure 6: Relay Terminal Connections AM-5150

4.0 Operation

When the **AM-5150** is installed as described in **Section 3**, and in clean air, the POWER green LED is on, the display is lit and the information on the display is measurement of the target detected by the **AM-5150**. The red alarm and fault LEDs are not lit.

4.1 Start Up AM-5150

When the **AM-5150** is first powered up, it goes through a series of momentary screens, which identify the instrument model number, serial number and software revision. After all the momentary screens have been displayed, the instrument arrives at the Main Gas Display showing the gas concentration and unit of measurement, ppm or %LEL. Depending on transmitter configuration and calibration condition, the furthest right character in the display may flash a letter indicating the instrument status. See the Section 4.1.1 below

4.1.1 Typical Start Up

When power is supplied to the **AM-5150**, the instrument will display the following sequence of information:
Typical start up sequence of information displayed.

Example of Typical Start Up Display	Function
AM-5150	The instrument: Model AM-5150
<i>Example for reference only</i> 311- 20	The instrument: Serial Number
<i>Example for reference only</i> S/W 6.6F	The instrument: Software Revision
IF the right most character is a flashing W OppW	The instrument is in Warm-up mode This should last about 1 minute The Signal Output is held at 4mA during warm-up
IF the right most character is a flashing C OppC	The instrument has failed Calibration The last good calibration values are retained, but the sensor may not be responsive to gas A new Calibration should be performed <i>As Soon As Possible</i>
Oppm OR 0LEL	The instrument: Normal Display Mode Measurement of the target gas
Oppm ↔ OppP	The instrument: in Purge Mode Display <i>Optional feature, not required in all instruments</i>
Oppm ↔ OppR	The instrument: in Recovery Mode Display <i>Optional feature, associated with purge mode</i>

NOTE: Software revision may cause variations of display output.

Prolonged storage of the **AM-5150-MOS** may result in some contamination of the sensor. Following start up, if the display reads above 000 a sensor purge function should be performed.

Sensor Purge: A sensor purge is performed to clean the MOS sensor (Metal Oxide Sensor) of molecules that may have settled on the sensor.

NOTE: Not all instruments are equipped with or require the Purge feature.

To determine if the purge feature is operational, press and **hold** the **SELECT** switch, 3 to 5 seconds, if purge feature is operational OppP appears in the display. If the **AM-5150-MOS** is equipped with the purge feature, the display will alternate between Oppm and OppP and the green Power/Fault LED will flash. In approximately 2 minutes the purge function will be completed and the display will, alternate between Oppm and OppR indicating the instrument is in recovery mode. Recovery mode lasts approximately 5 minutes. When the purge cycle is complete, the display will become stable at Oppm and the green Power/Fault LED will stop flashing.

4.2 Normal Display Mode

When the **AM-5150** is installed as described in section 3, and in clean air, the POWER green LED is on, the display is lit and the information on the display in measurement units of ppm or %LEL detected by the **AM-5150**. The red alarm and fault LEDs are not lit.

To advance through displays of operational information press the **MENU** button.

NOTE: Software revision may cause variations of display output.

See sequence of operational information below:

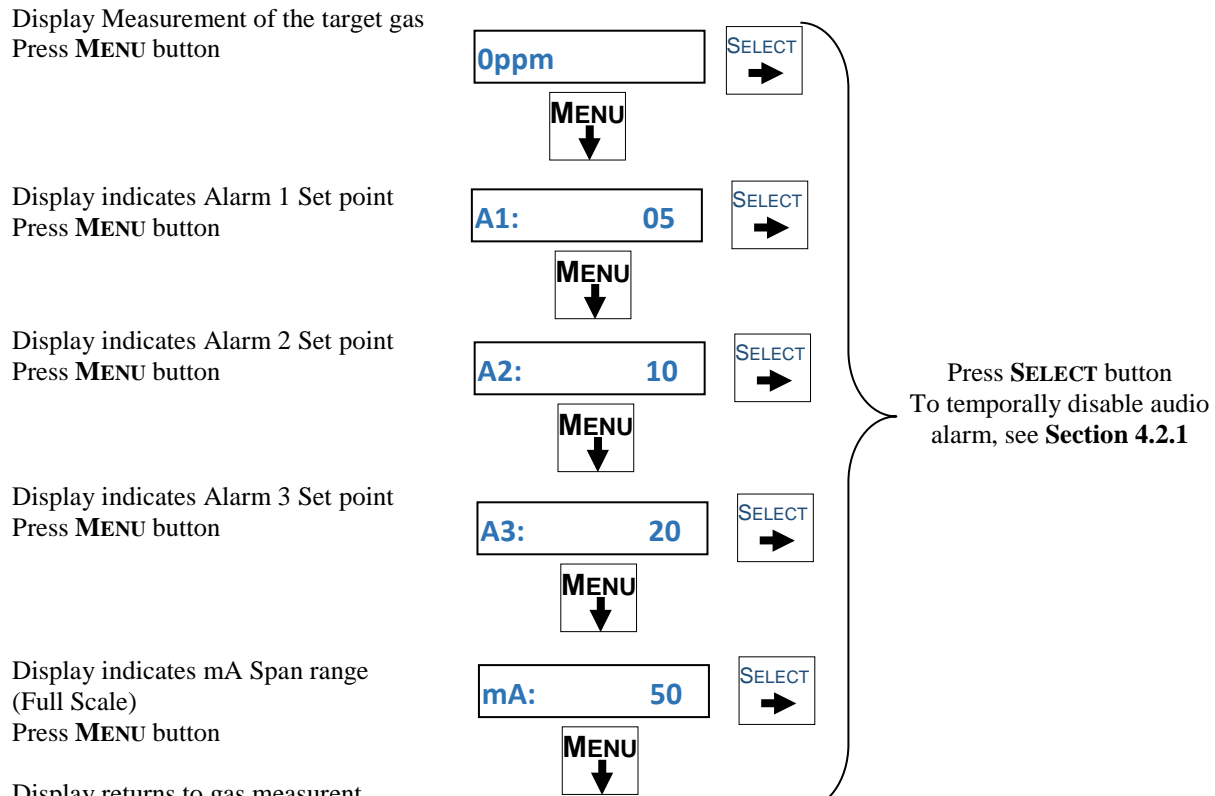

Operational Display Flow Chart

4.2.1 Alarm Conditions AM-5150

There are three alarm set points available. These alarm points are normally set at established safety levels, such as the OSHA Permissible Exposure Limit (PEL) for toxic gases or recognized standards below the Lower Explosive Limit for combustible gases.

The alarm set points can be changed within limits; see the maintenance section of this manual for the procedure.

If the gas concentration increases above that of the alarm set point, the associated red LED is lit, the associated relay changes state, and the audio alarm is activated.

Pressing the **SELECT** button can temporarily disable the Audio Alarm. The horn will be disabled for about five minutes. If a second alarm condition occurs during this time the horn will re-activate. If the alarm condition(s) have ended during this time the horn will not re-activate.

5.0 Maintenance

The **AM-5150** maintenance menus that are accessed by pressing the **MENU** button and **SELECT** button as described in the maintenance menu section.

5.1 Maintenance Menus





Pushbutton switches control the **MENU** and **SELECT** functions. The **MENU** and **SELECT** button locations are indicated on the display panel, see **Figure 1**. The **MENU** button is used to display the various menu options and make incremental changes to numbers such as alarm points, calibrations gas, etc. The **SELECT** button is used to select that option, set zero or span digit. To enter the maintenance menu, press and **hold** the **MENU** button for 2 to 4 seconds

Table 2 indicates the maintenance menu sequence see **Figure 7** for a detailed maintenance menu flow chart.

CAUTION: *Do Not Attempt a Span Procedure Without Calibration Gas Applied to The Sensor; if this is done, the instrument is forced into a calibration fault mode.*

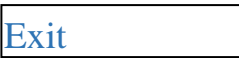
NOTE: *Software revision may cause variations of display output.*

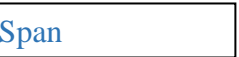
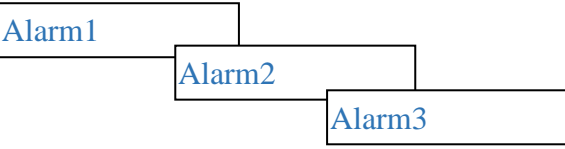
Table 2: AM-5150 Maintenance Menu Sequence

Example of Display	Function
Normal Display Mode 	Measurement of CO
Press and hold the MENU button for 2 – 4 seconds to enter the Maintenance Menu The Power/Fault LED will flash Green – Red to indicate the AM-5150 is in Maintenance Mode	
	To exit the maintenance Menu and return to the Normal Display Mode: If intended function Press SELECT button
Press the MENU button to advance to the Zero procedure	
	For adjusting Zero: If intended function Press SELECT button
Press the MENU button to advance to the Span procedure	
	For adjusting the Span: If intended function Press SELECT button
Press the MENU button to advance to each Alarm set point procedures	
	For adjusting the Alarm 1, 2 and 3 set points: If Intended function, press SELECT button.
Press the MENU button to advance the mA Span set point procedure	
	For adjusting the mA Span set point: If intended function Press SELECT button

Pressing the **MENU** button without pressing the **SELECT** button will allow you to cycle through the menu options. You must Press the **SELECT** button to initiate the desired operation.

NOTE: Software revision may cause variations of display output.

Normal Gas Display

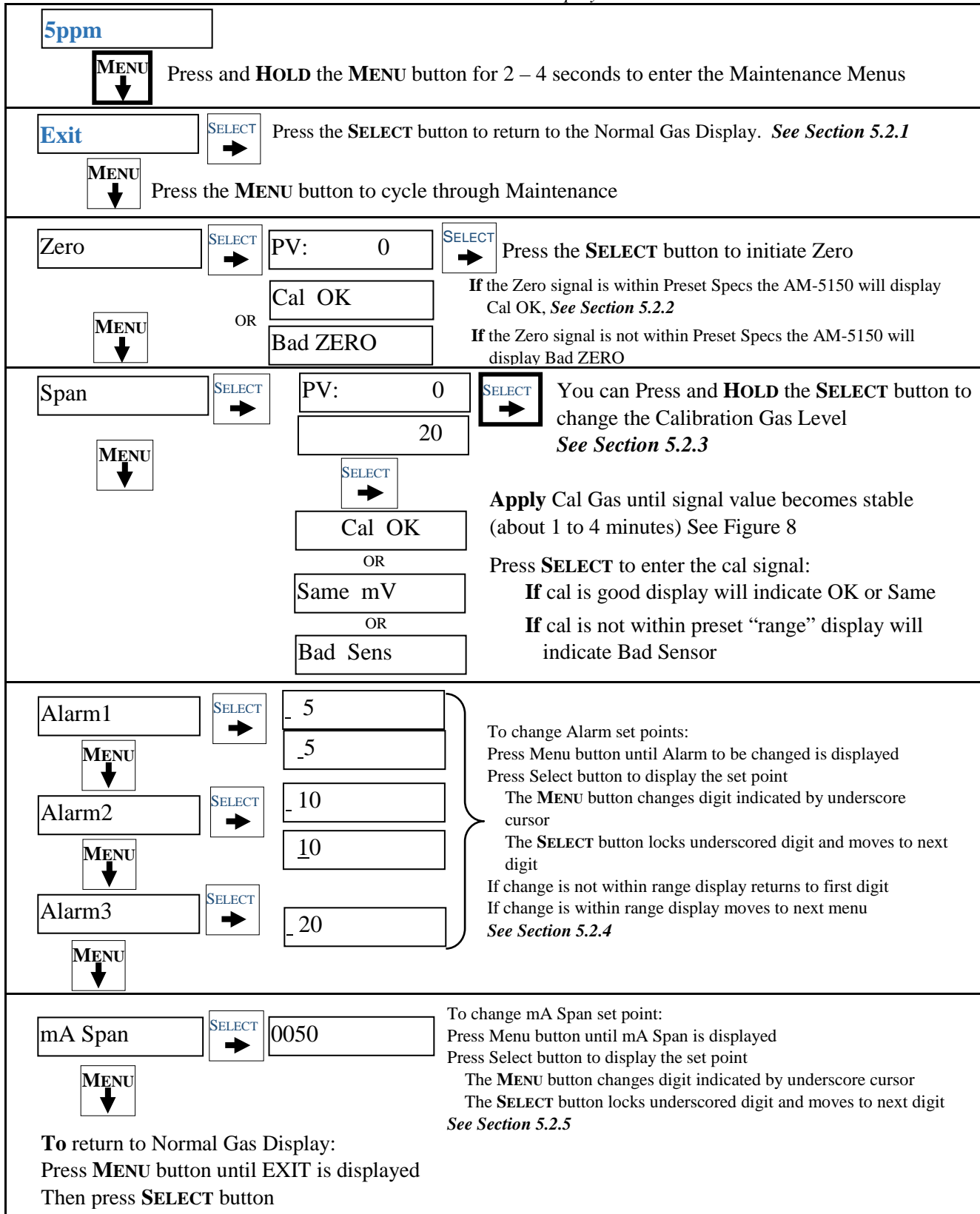

Figure 7: AM-5150 Maintenance Menu Flow Chart

5.2 Calibration of the AM-5150

Sensor Purge: Prior to calibration some MOS (Metal Oxide Sensor) sensor should be purged. A sensor purge is performed to clean the MOS sensor of molecules that may have settled on the sensor.

Press and **hold** the **SELECT** switch, 3 to 5 seconds, if the purge feature is operational OppP appears in the display. If the **AM-5150-MOS** is equipped with the purge feature, the display will alternate between Oppm and OppP and the green Power/Fault LED will flash.

Example of purge display



In approximately 2 minutes the purge function will be completed and the display will, alternate between Oppm and OppR indicating the instrument is in recovery mode. Recovery mode lasts approximately 5 minutes.

Example of purge recovery display

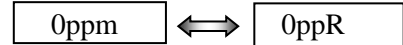

When the purge cycle is complete, the display will become stable at 0ppm and the green Power/Fault LED will stop flashing. Calibration is the process of setting the instrument up to read accurately when exposed to the target gas. The Zero function sets the clean air reference point and the Span function sets the sensitivity of the instrument.

Initial Calibration: Wait at least 3 – 4 hours after initially supplying power to the **AM-5150** instrument before initial calibration, overnight is preferred. The **AM-5150** has been pre-calibrated at the factory, and initial field calibration should result in only fine-tuning to circuit, as well to check that installation is successful. It is not necessary to open the enclosure to make adjustment. The calibration functions are operated with pushbuttons from outside the enclosure through the **MENU** and **SELECT** switches. Calibration Zero and Span functions are two separate procedures. They operate independently of each other. It is recommended that the Zero procedure be done prior to the Span procedure.

ENMET recommends at least quarterly calibration of the AM-5150 instrument.

Calibration equipment is available from **ENMET** to calibrate the **AM-5150** instrument.

- Calibration adapter, a length of tubing with a regulator for the gas cylinder on one end, and a calibration cup to connect to the sensor of the **AM-5150** on the other.
- Gas cylinder, zero gas 20.9% oxygen or Span gas, factory determined, varies by intent.

Generally, a cylinder of 20.9% Oxygen is used to provide a Zero point or fresh air reference for the calibration.

NOTE: *Software revision may cause variations of display output.*

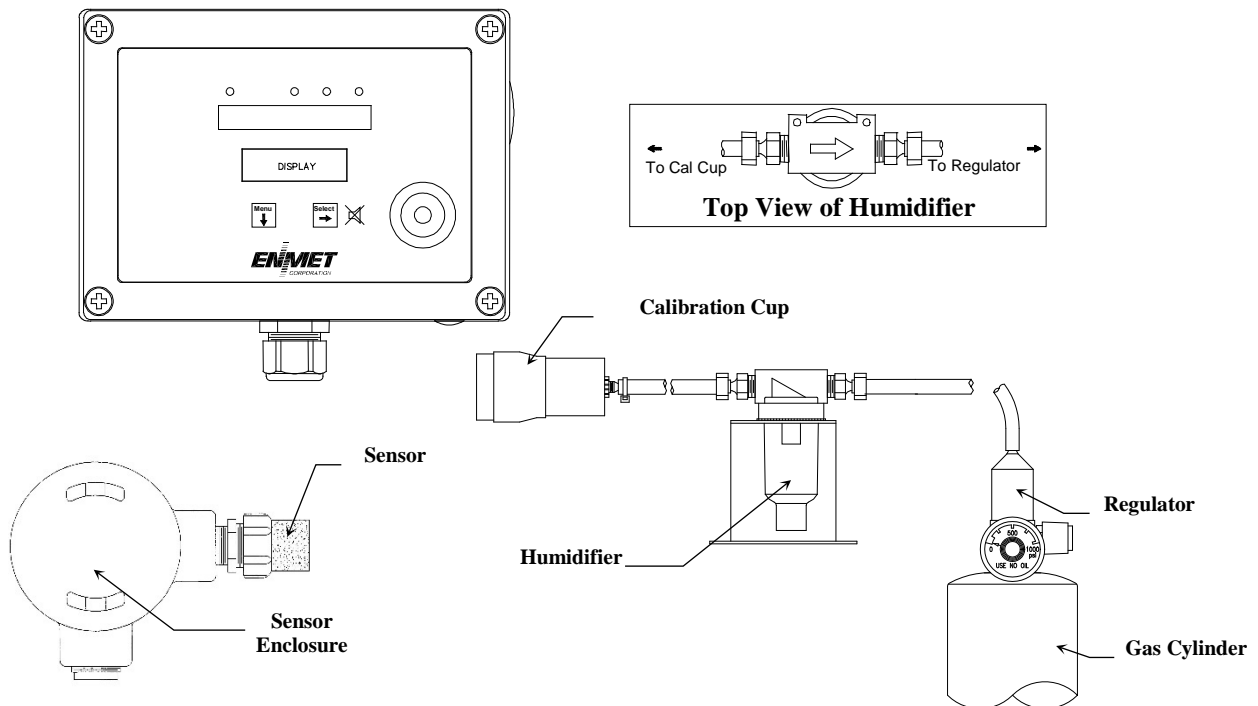
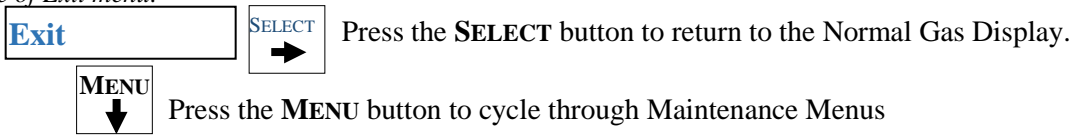

Figure 8: Calibration Adapter

5.2.1 Exit Maintenance Menu

Exit maintenance, by pressing the Exit appears on the display. Press the **SELECT** button to return to the instrument Normal Gas Display.

Example of Exit menu:



5.2.2 Zero Adjust

The ZERO function must be performed by exposing the **AM-5150** instrument to clean fresh air. If the air at the sensor is in question, use a cylinder of 20.9% oxygen to provide a clean air reference.

Enter the maintenance menu by pressing and holding **MENU** button for 2 to 4 seconds. See **Figure 7, AM-5150** Maintenance Menu flow chart.

After entering the maintenance menu, Press the **MENU** button until the Zero menu is displayed. Press the **SELECT** button to perform a Zero.

The display will alternate between Zero and PV: To abort Zero function press and hold **MENU** button for 3 – 4 seconds, Abort? will appear, press **SELECT** button to return to Zero.

Press the **SELECT** button to initiate a Zero adjustment.

An auto detect sequence is initiated. After 15 seconds, the **AM-5150** will monitor the zero reading for stability.

- *If the reading stabilizes*, within the pre-programmed perimeters, an automatic zero adjustment will be made. Cal OK appears on the display and in 1 – 2 seconds, display will change to Span. If you wish to Span the sensor press the **SELECT** button you are now ready to apply gas. **Proceed to gas span step 2** If you wish to Exit the maintenance menu, press **MENU** button until Exit is displayed, then press **SELECT** button to return to the instrument Normal Gas Display
- *If the reading does not stabilize*, within 255 seconds, the procedure will be aborted. Sensor is outside of safe parameters to be zeroed, the display will read Bad Zero. Repeat Section 5.2.2 Zero Adjust making sure to use a Zero gas of 20.9% Oxygen. **ENMET** part number 03296-209.

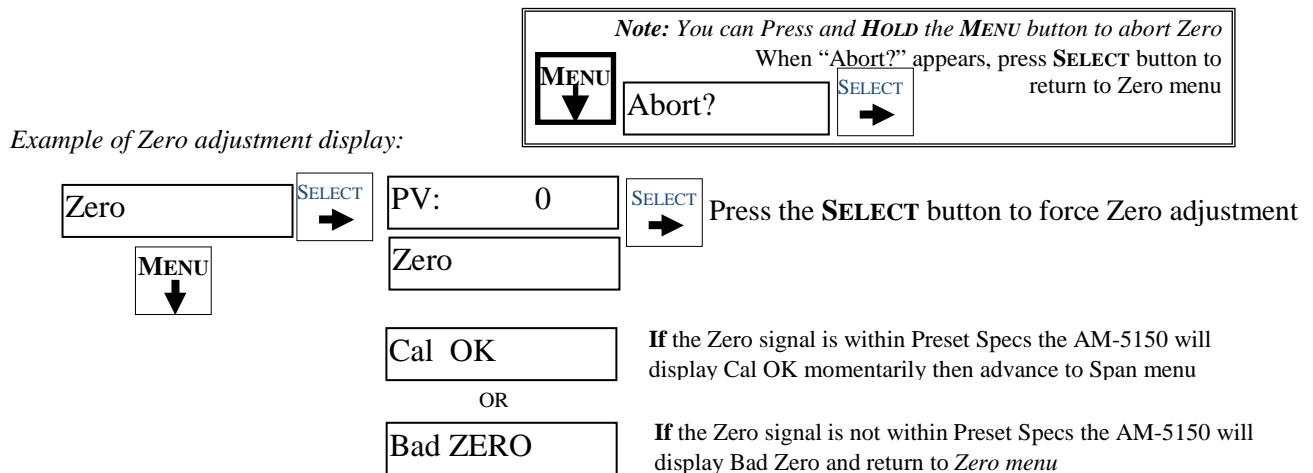

NOTE: Software revision may cause variations of display output.

5.2.3 Gas Span

It is recommended that the Zero Function be performed first.

Do not perform a calibration unless span gas is applied to sensor. Calibration can be aborted by pressing and holding the MENU button for 3 – 4 seconds.

Enter the maintenance menu. See **Figure 7, AM-5150 Maintenance Menu** flow chart.

1. Press the MENU button until Span display.
2. Press the SELECT button to perform a Span procedure.
The display will alternate between the calibration gas concentration (*Example*: Cal 20) and a signal level (PV).
 - To Abort calibration press and Hold MENU button for 3 – 4 seconds, “Abort?” will appear, press SELECT button to return to Span.

NOTE: To abort calibration. Press and **HOLD** the MENU button to abort Calibration
When “Abort?” appears, press SELECT button to advance to desired menu

MENU
↓

Abort?

SELECT
→

- To change calibration gas level to be used, press and Hold SELECT button for 3 – 4 seconds, use menu button to change digit and select button to move to next digit.

NOTE: To change calibration gas level. Press and **HOLD** the SELECT button to change the Calibration Gas Level

SELECT
→

-Use the MENU button to change digits
-Use the SELECT button to move to next digit

20

3. Attach the associated calibration gas cylinder to the calibration adapter. See **Figure 8** calibration adapter.
4. Open the valve to apply the calibration gas to the sensor.
An auto detect sequence is initiated after 30 seconds, the AM-5150 will monitor the cal reading for stability.
5. Watch for the signal level to stabilize. This should take about 1 – 4 minutes.
6. Once the signal level has stabilized,
 - If the Span is successful, Cal OK appears momentarily, then will advance to Alarm1 menu.
To exit cal, press MENU button until Exit appears and press SELECT button
 - If the sensor is outside of acceptable parameters, Bad Span is displayed.
 - If the sensor did not respond, an incompatible span gas was applied and the sensor did not respond at all, Same mV is displayed then will return to Span.
- ➔ If calibration is not successful, it is suggested that calibration be attempted again in 30-60 minutes.
If the sensor will not calibrate See **Section 5.3** for sensor replacement.
7. Remove the calibration gas.
8. Press the MENU button to advance to Exit menu or desired menu.

NOTE: Software revision may cause variations of display output.

Example of Calibration Display:

Span

SELECT
→

PV: 0

SELECT
→

MENU
↓

PV: 0

20

Cal OK

Bad Sens

OR

Same mV

Apply Cal Gas until signal value becomes stable
(about 1 to 4 minutes) See **Figure 8** Calibration Adapter

When cal signal is stable AM-5150 will automatically update:

If cal is good display will indicate OK or Same and advance to Alarm1

If cal is not within preset “range” display will indicate Bad Sensor Same mV the AM-5150 will return to the Span Menu

To exit press MENU button until Exit appears and press SELECT

5.2.4 Alarm Set Points

The AM-5150 has three alarm set points set at the factory. These alarm points are normally set at established safety levels. Alarm set points can be changed within limits.

To change any of the three alarm points:

Enter the maintenance menu as shown in **Figure 7 AM-5150 Maintenance Menu** flow chart.

1. Press the **MENU** button until Alarm1 is displayed.
2. Press the **SELECT** button to initiate alarm set point change
3. Press the **MENU** button to change the digit indicated by the underscore cursor
4. Press the **SELECT** button to move the cursor to the next digit
When last digit is entered the AM-5150 will advance to the next menu
5. Press the **MENU** button to advance to the next menu

NOTE: Alarms 2 and 3 cannot be set below the Alarm 1 setting.

Example of Alarm Set Point menus:

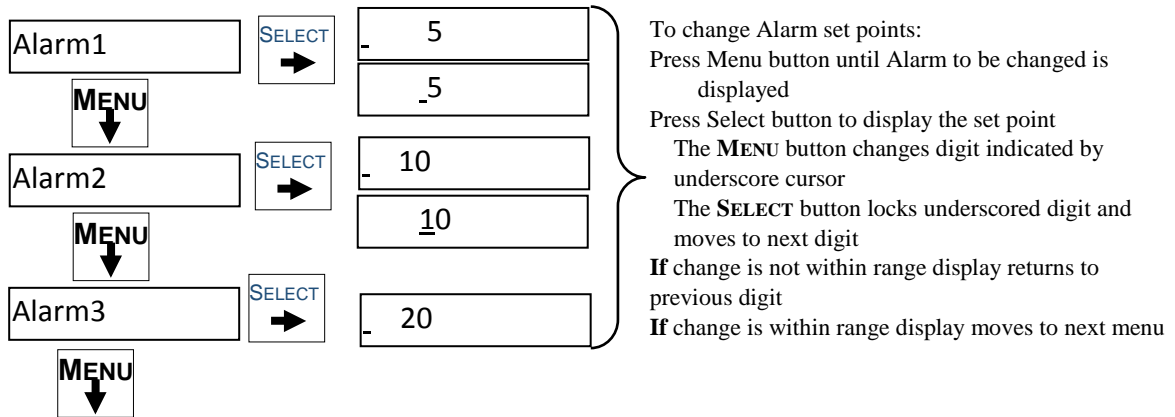

NOTE: Software revision may cause variations of display output.

5.2.5 mA Span Set

The AM-5150 4-20mA span range is set at the factory, normally to the full scale of the measurement and can be changed within limits.

To change the span range:

Enter the maintenance menu as shown in **Figure 7 AM-5150 Maintenance Menu** flow chart.

1. Press the **MENU** button until to display Span is displayed.
2. Press the **SELECT** button to initiate the mA Span menu
3. Press the **MENU** button to change the digit indicated by the underscore cursor
4. Press the **SELECT** button to move the cursor to the next digit
When last digit is entered the AM-5150 will advance to the next menu
5. Press the **MENU** button to advance to the next menu

Example of mA Span menu:

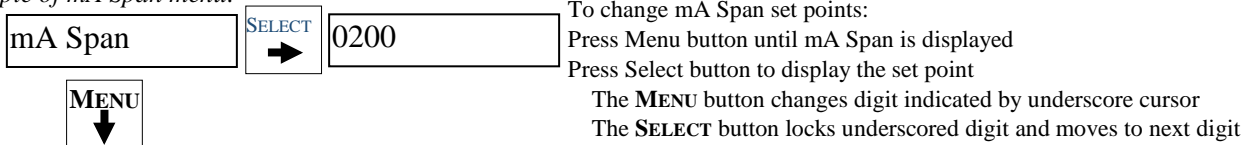

Default mA Span

4mA	20mA
0 ppm	200 ppm

5.3 Sensor Replacement

The MOS sensor is durable, it can be purged of contaminants by operating in PURGE for a sufficient length of time and at regular intervals.

Gross contamination usually occurs during unavoidable misuse. Close exposure to an open gas flame, submersion of the sensor in a liquid, or continuous exposure to heavy concentrations of industrial vapors will grossly contaminate a sensor. A grossly contaminated sensor causes a continuous alarm.

If a sensor fails to calibrate, replace it.

PROCEDURE:

WARNING: Power must be removed from the AM-5150 before this or any internal procedure. Failure to do so may cause damage to equipment, bodily injury or death.

1. Obtain a new sensor assembly. Make sure the sensor type is identical to your original sensor
Sensor marking is on side of sensor see **Figure 9**
(Example: 813-4 the first 3 digits are sensor ID the 4 digit indicates a 4-wire sensor).
2. Disconnect the instrument for power.
3. Disconnect the orange, brown, blue and yellow sensor wires.
4. Unscrew the assembly from the sensor enclosure.
5. Remove the bad sensor.
6. Replace with the new sensor and reconnect the wires (See Section 3.2.1).

NOTE: The user must perform the four color-coded wiring attachments when replacing the sensor. If the yellow signal wire is **not** connected to the terminal block, use supplied wire nut.

7. Reconnect the instrument to power and verify sensor heater voltage. (See Section 3.2.1)
8. Recalibrate the instrument (See Section 5.3.1).

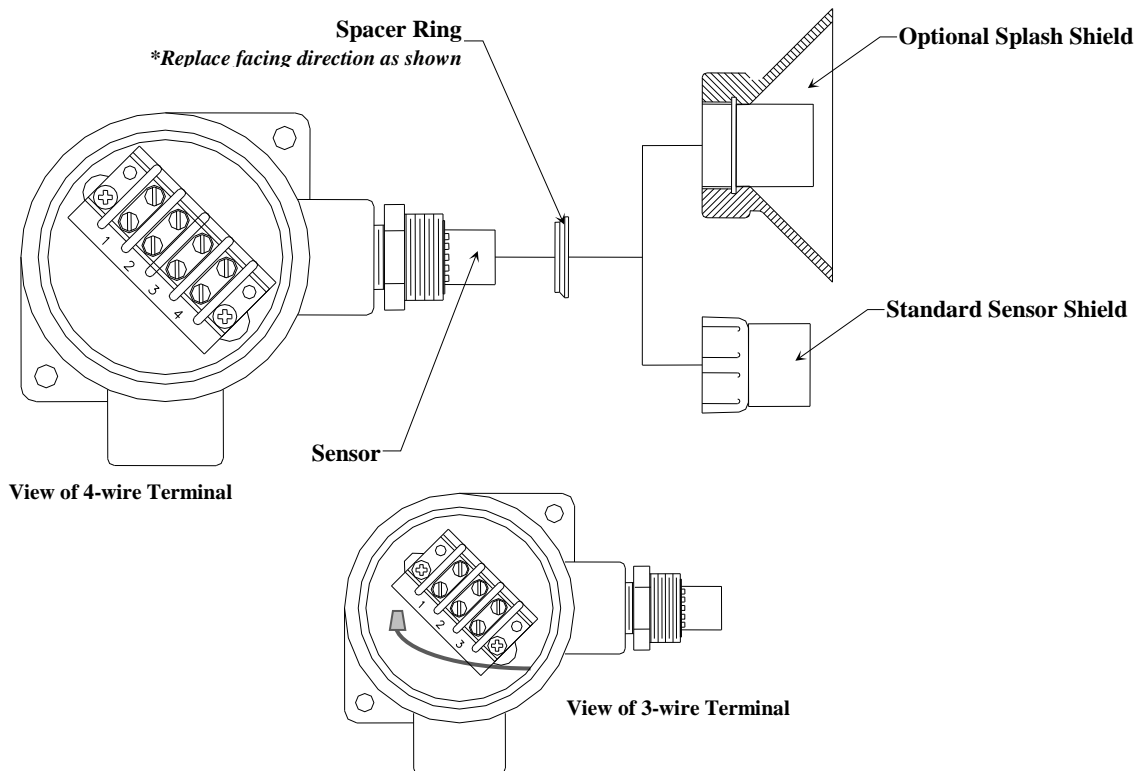

Figure 9: AM-5150 Sensor Replacement

After the new sensor assembly has been installed, it is suggested to allow the sensor to stabilize for at least 3 – 4 hours, preferably overnight.

5.3.1 Sensor Replacement Calibration

Sensor Purge: Prior to calibration some MOS (Metal Oxide Sensor) sensor should be purged. A sensor purge is performed to clean the MOS sensor of molecules that may have settled on the sensor.

Press and **hold** the **SELECT** switch, 3 to 5 seconds, if the purge feature is operational 0ppP appears in the display. If the **AM-5150-MOS** is equipped with the purge feature, the display will alternate between 0ppm and 0ppP and the green Power/Fault LED will flash.

Example of purge display



In approximately 2 minutes the purge function will be completed and the display will, alternate between 0ppm and 0ppR indicating the instrument is in recovery mode. Recovery mode lasts approximately 5 minutes.

Example of purge recovery display

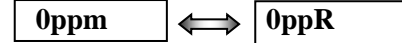

When the purge cycle is complete, the display will become stable at 0ppm and the green Power/Fault LED will stop flashing. Calibration is the process of setting the instrument up to read accurately when exposed to the target gas. The Zero function sets the clean air reference point and the Span function sets the sensitivity of the instrument.

Initial Calibration: Wait at least 3 – 4 hours after initially supplying power to the **AM-5150** instrument before initial calibration, overnight is preferred. The **AM-5150** has been pre-calibrated at the factory, and initial field calibration should result in only fine-tuning to circuit, as well to check that installation is successful. It is not necessary to open the enclosure to make adjustment.

The calibration functions are operated with pushbuttons from outside the enclosure through the **MENU** and **SELECT** switches.

Calibration Zero and Span functions are two separate procedures. They operate independently of each other. It is recommended that the Zero procedure be done prior to the Span procedure.

ENMET recommends at least quarterly calibration of the AM-5150 instrument.

Calibration equipment is available from **ENMET** to calibrate the **AM-5150** instrument.

- Calibration adapter, a length of tubing with a regulator for the gas cylinder on one end, and a calibration cup to connect to the sensor of the **AM-5150** on the other.
- Gas cylinder, zero gas 20.9% oxygen or Span gas, factory determined, varies by intent.

Generally, a cylinder of 20.9% Oxygen is used to provide a Zero point or fresh air reference for the calibration.

NOTE: *Software revision may cause variations of display output.*

After entering the Maintenance menu, press and hold the **MENU** button for 2-4 seconds while viewing the Zero menu.

After 2-4 seconds, an F will appear on the far-right hand side of the display. The F indicates that the instrument is in Factory mode.

Perform the calibration Zero and Span procedures as outlined in **Section 5.2**. Be sure that the F is present when selecting the Zero and Span functions.

The Factory calibration sets a calibration window for future standard instrument calibrations.

6.0 Accessory and Replacement Parts

ENMET accessory part numbers:

Description of Part	Part Number
Sensor Marking, 109-4	03034-109
Sensor Marking, 812-4	03034-812
Sensor Marking, 813-4	03034-813
Sensor Marking, 018-4	03034-018
Sensor Marking, 019-4	03034-019
Sensor Marking, 821-4	03034-821
Sensor Marking, 830-4	03034-830
Sensor Marking, 832-4	03034-832
Zero Gas, 20.9% O ₂ , 17 liters	03296-209
Span Gas	
Cylinder of Calibration Gas	Contact ENMET for part number of target gas for each instrument. See note below.

NOTE: The gases should be identical, or equivalent (correlation gas) to those used to initially calibrate the unit, unless you want to recalibrate to a new gas or different concentration. In addition, calibration gases must be in a background of air; do not use gases with an inert gas background (such as nitrogen or argon).

7.0 Technical Data and Specifications

Electrical Power	15 Amp fused branch circuit	
	100-240 VAC	
	0.45A, 50/60 Hz	
	0.6A, 24VDC	
Storage and Transport	Temperature:	-20° to +60°C (-4° to +140°F)
	<i>preferred</i>	0° to +20°C (32° to 68°F)
	Relative Humidity	10-99% RH, non-condensing
	Atmospheric Pressure	20 to 36 inHg (68 to 133 kPa)
Operation	Temperature:	-15° to +40°C (5° to +104°F)
	Relative Humidity	10-99% RH, non-condensing
	Atmospheric Pressure	20 to 36 inHg (68 to 133 kPa)
Mechanical	Dimensions:	7.1 x 5.1 x 3 in(180x130x75mm)
	Weight:	2 lbs (0.9 kg)
	Material:	Polycarbonate
	Strain relief:	3-6.5mm OD
Outputs	Relays:	SPDT Resistive Load Inductive Load 10A at 110 VAC 7.5A at 110 VAC 10A at 30 VDC 5A at 30 VDC
	Analog:	4-20mA
	Digital:	RS-485-modbus
	Audio:	105 dB at 30cm/12in

NOTE: All specifications stated in this manual may change without notice.

Notes:

8.0 Terms and Conditions

8.1 Ordering Information

Address orders to:

ENMET
Attention: Customer Service Department
680 Fairfield Court
Ann Arbor, MI 48108

Email Orders: orderentry@enmet.com

Phone: 734-761-1270

Fax: 734-761-3220

You may also contact our customer service department by email info@enmet.com. MINIMUM ORDER IS \$50.00.

8.2 Delivery

Unless Seller otherwise specifies, delivery will be made: FOB Ann Arbor, MI and/or FOB Bowling Green, KY. Title and risk of loss shall pass to Buyer at that point. Shipping and handling charges will be Prepaid and Added to Buyer's invoice. Buyer may request shipping be charged to their own account with a preferred carrier. Seller shall have the right to choose means of transportation and to route shipment when specific instructions are not included with Buyer's order. Seller agrees to deliver the goods and services, within the time, in accordance with specifications, at the prices specified on the face hereof. Buyer's orders to this quotation are not subject to cancellation or deferment of delivery without indemnification of loss to the Seller resulting therefrom. Seller shall not be liable to Buyer for any loss or damage sustained on account of this delay or nonperformance due to causes beyond Seller's control and without his fault or negligence. Where performance of the terms here is contingent upon timely delivery of goods or services by the Buyer and such delivery is in default, Seller shall be indemnified for any damage or loss resulting therefrom, and/or by extension of Seller's delivery commitment, as applicable.

8.3 Payment Terms

Payment Terms are Net 30 Days from the date of shipment from Seller unless otherwise noted. All shipping and handling costs will be charged to Buyer on a Prepaid and Add basis. Buyer has the option of paying for shipping by charging its own account with a carrier

8.4 Warranty Information and Guidelines

The Seller warrants new instruments to be free from defects in workmanship and material under normal use for a period of one year from date of shipment. The warrant covers both parts and labor excluding calibration and expendable parts such as filters, detector tubes, batteries, etc. If the inspection by the Seller confirms that the product is defective, it will be repaired or replaced at no charge, within the stated limitations, and returned prepaid to any location in the United States. The Seller shall not be liable for any loss or damage caused by the improper use or installation of the product. The Buyer indemnifies and saves harmless the Seller with respect to any loss or damages that may arise through the use by the Buyer or others of this equipment. This warranty is expressly given in lieu of all other warranties, either expressed, implied or statutory, including that of merchantability, and all other obligations, or liabilities of ENMET, LLC for damages arising out of or in connection with the use or repair or performance of the product. In no event shall ENMET, LLC, be liable for any indirect, incidental, special or consequential damages or for any delay in the performance by ENMET, LLC, which may arise in connection with this equipment. ENMET neither assumes nor authorizes any representatives or other persons to assume for it any obligation or liability other than that which is set forth herein. Buyer agrees to indemnify and save harmless Seller for any damage or loss from lawsuits against Seller by reason of manufacture of sale of materials, parts, or use of processes resulting from Buyer's design specifications. Any patent, design, pattern, tool, die, jig, fixture, drawing, test equipment, or process furnished by Seller; whether possessed by the Seller before the date of this quotation, or devised or acquired by Seller during performance of the terms of this quotation, shall remain the property of the Seller except by specific stipulation on the face hereof. Seller reserves the right, without liability, for damage or loss, to destroy Buyer's drawings, specifications, patterns and special tools supplied by Buyer for performance of the terms on the face hereof, unless Buyer gives notice of the disposition of such items.

8.5 Return Policy

All returns for credit must be approved in advance by ENMET, LLC. Such returns are subject to a minimum \$50.00 or 20% restocking charge, whichever is greater. **Approval of equipment for return is totally at the discretion of ENMET, LLC.** All requests for return/exchange must be made no later 30 days of the original shipping date from ENMET. The actual amount of any resulting credit will not be determined prior to a complete inspection of the equipment by ENMET. Calibration gas cylinders cannot be returned or restocked.

9.0 Instructions for Returning an Instrument for Service

Contact the ENMET Service Department for all service requests.

Phone: 734-761-1270

Email: repair@enmet.com

Fill out the “Service Request Form” found at the end of this manual and return with your instrument for all needs. Please send your instrument for service to the site in which the product was purchased. A new “Service Request Form” may be requested if the one found in the manual is not available. All instruments should be shipped prepaid to ENMET.

Address for Service:

Michigan Location:

ENMET
Attention: Service Department
680 Fairfield Court
Ann Arbor, MI 48108

Kentucky Location:

ENMET
62 Corporate Court
Bowling Green, KY 42103

Providing the “Service Request Form” assists in the expedient service and return of your unit and failure to provide this information can result in processing delays. **ENMET** charges a one hour minimum billing for all approved repairs with additional time billed to the closest tenth of an hour. All instruments sent to **ENMET** are subject to a minimum evaluation fee, even if returned unrepared. Unclaimed instruments that **ENMET** has received without appropriate paperwork or attempts to advise repair costs that have been unanswered after a period of 60 days may, be disposed of or returned unrepared COD and the customer will be expected to pay the evaluation fee. Serviced instruments are returned by UPS/FedEx Ground and are not insured unless otherwise specified. If expedited shipping methods or insurance is required, it must be stated in your paperwork.

NOTE: *Warranty of customer installed components.*

For Warranty Repairs, please reference **ENMET's** “Warranty Information and Guidelines” (found earlier in this section).

Mailing/Shipping Address:

ENMET
680 Fairfield Court
Ann Arbor, MI 48108
repair@enmet.com



Phone: 734.761.1270
Fax: 734.761.3220

Service Request Form

Product Name or Number:

Product Serial Number:

Describe Problem or Needed Service:

Warranty Claim? Yes No

CUSTOMER INFORMATION

Billing Address:

Shipping Address:

Contact Name:

Phone #:

Email:

Fax #:

PO/Reference

#:

PAYMENT METHOD

COD VISA/MasterCard American Express

Card Number

Exp. Date

Security Code:

Name as it Appears on

Card:

RETURN SHIPPING METHOD

UPS Ground UPS 3 Day Select UPS Next Day Air UPS ND Air Saver UPS 2 Day Air

UPS Account #: _____

FedEx Ground FedEx Air Express Saver FedEx Air Overnight Std. FedEx Air 2 Day FedEx Air Overnight P-1

FedEx Account #: _____

Insure Shipment: Yes No

Insurance \$
Amount: _____